



L-Università
ta' Malta

On Walks and Canonical Double Coverings of Graphs with the same Main Eigenspace

by

LUKE COLLINS

A dissertation submitted in partial fulfillment of the requirements for the
Degree of Bachelor of Science (Honours) in Mathematics as a main area.

Department of Mathematics

Faculty of Science

UNIVERSITY OF MALTA

May 2019

“Why are numbers beautiful? It’s like asking why is Beethoven’s Ninth Symphony beautiful. If you don’t see why, someone can’t tell you. I know numbers are beautiful. If they aren’t beautiful, nothing is.”

PAUL ERDŐS

Abstract

The main eigenvalues of a graph G are the eigenvalues of its $(0, 1)$ -adjacency matrix having some corresponding eigenvector not orthogonal to the all-ones vector $\mathbf{j} = (1, \dots, 1)$. In this dissertation, the relationship between the main eigenvalues of a graph and the number of walks is discussed. The number of walks N_k of length k in the graph G is expressed solely in terms of the main eigenvalues and main angles of G . The walk matrices of two co-main non-isomorphic graphs with the same main eigenspace are shown to be of the same column space. Moreover, various properties of graphs relating the main eigenvalues, eigenspaces, eigenvectors and canonical double covers are categorised in a hierarchical form.

Contents

Preface	vi
0 Introduction	1
0.1 Basic Terminology	1
0.2 Some Basic Results	5
0.3 Document Structure	7
1 Preliminary Matrix Theory	8
1.1 Permutation Matrices	8
1.2 Spectral Results	12
1.2.1 Orthogonal Projections	13
1.2.2 The Spectral Theorem	16
1.3 Number of Walks	20
1.4 Gauss' Lemma	22
2 Main Eigenvalues	24
2.1 Main Angles	24
2.2 The Main Polynomial	26
2.3 The Main Eigenspace	29
2.4 The Walk Matrix	30
3 Canonical Double Covers	34
3.1 Two Structural Results	36
3.2 Graphs with the same CDC	38
3.3 Establishing a Hierarchy	40

Appendix A All Pairs of TF-Isomorphic Graphs on 8 Vertices	48
A.1 The List	48
Bibliography	58
Index	60

List of Figures

1	Illustration of the Königsberg bridge puzzle ^[10]	vii
1	Three equivalent representations of the graph G	2
1.1	Illustration of definition 1.8 in \mathbb{R}^2	14
2.1	The only two counterexamples on ≤ 8 vertices, as described in counterexample 2.17.	33
3.1	Canonical double coverings of C_3 and $K_{2,3}$, where vertices $(v, 0)$ are represented by circle nodes, and vertices $(v, 1)$ by square nodes.	35
3.2	The hierarchy we present through our results. The arrow \Rightarrow means “implies”, and \nRightarrow means “does not imply”. The combination \Leftrightarrow is short for \Rightarrow and \Leftarrow , i.e., “implies and is implied by”, and similarly \nLeftrightarrow is short for \nRightarrow and \nLeftarrow , i.e., “does not imply and is not implied by”. The dashed lines which merge at the \wedge node denote the conjunction of those two results. The dotted lines denote a conjecture.	41
3.3	Graphs G and H give a counterexample to the converse of theorem 3.5, since they have the same walk matrix but different CDC’s.	42
3.4	Graphs G and H have the same main eigenvalues, but have different walk matrices.	43
3.5	Graphs G and H have the same main eigenvectors, but have different walk matrices.	45
3.6	Graphs G and H have related walk matrices.	46

Preface

A graph is a network of abstract objects called vertices in which some pairs are related: such pairs are called edges. Pictorially, the vertices are represented by dots, and edges are represented by lines joining those dots. A graph with n vertices can be represented algebraically using an $n \times n$ matrix, where the i th row and j th column contains a 1 entry if vertex i is connected to vertex j , and a 0 entry if they are not connected. This is called the adjacency matrix.

In applications, graphs are abstract representations of structures in which items are connected. Social networking sites, such as Facebook, make use of graphs to represent “friends” (vertices) and “friendships” (edges). Problems of finding “mutual friends”, for example, make use of graph theoretic results. Graphs are also fundamental to the effectiveness of Google’s PageRank algorithm, which determines the order in which results appear in a Google search. In this context, vertices represent different webpages, and two webpages are connected if one links to the other. A walk in such a graph corresponds to starting from one webpage, and clicking links to travel to others. If a large number of walks end in a particular webpage, then that webpage is “popular” so it is promoted more than others.

Historically, graph theory was first conceived when Euler released a paper on the Königsberg bridge problem in 1736, which led to his formula relating edges, vertices and faces of convex polyhedra. This paper is often pointed to as the birth of graph theory and topology.

Spectral graph theory is the study of graphs from a linear algebraic point of

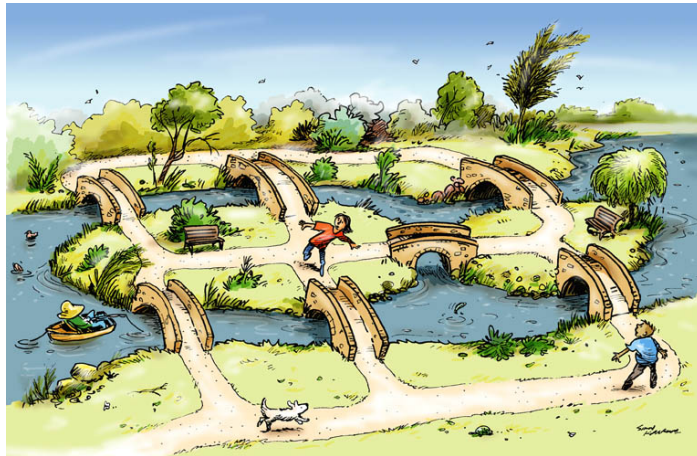

FIGURE 1: Illustration of the Königsberg bridge puzzle^[10]

view. The subject explores the relation of the graph with the characteristic polynomial, eigenvalues and eigenvectors of its adjacency matrix. Since adjacency matrices are $(0, 1)$ -real symmetric matrices, a number of facts from linear algebra can be tailored more specifically to graphs, and this often results in significant strengthening of results.

Spectral graph theory emerged in the mid-twentieth century. The monograph by Cvetović, Doob and Sachs, *Spectra of Graphs* (1980), summarises a large portion of the important results in this area.^[6]

Introduction

*“We can only see a short distance ahead,
but we can see plenty there that needs to
be done.”*

ALAN TURING

In this chapter, we establish some basic notation and terminology that will be used throughout and state some rudimentary results, before giving an overview of the structure of the document.

0.1 Basic Terminology

Unless stated otherwise, small letters such as x , f or ϕ denote functions or elements (members) of a set, ordinary capital letters such as X , U or Ω denote sets, cursive capital letters such as \mathcal{V} , \mathcal{U} or \mathcal{E} denote vertex/edge sets, sans-serif capital letters such as G or P denote the names of graphs, small letters in bold font such as x or v denote vectors, and capitalised bold letters such as \mathbf{A} or \mathbf{M} denote matrices.

The set of positive integers $\{1, 2, 3, \dots\}$ is denoted by the symbol \mathbb{N} , and for any $n \in \mathbb{N}$ the subset $\{m \in \mathbb{N} : m \leq n\} = \{1, \dots, n\}$ is denoted by $[n]$. For any set A , we denote the cardinality by $|A|$, and the power set $\{X : X \subseteq A\}$ by $\wp A$. For any finite set A , we denote the set $\{X \in \wp A : |X| = k\}$ of all k -element subsets by $\binom{A}{k}$. The Cartesian product of k sets A_1, A_2, \dots, A_k is denoted $A_1 \times \dots \times A_k$ or $\prod_{i=1}^k A_i$, and if $A_i = A$ for all $i = 1, \dots, k$, then we simply write A^k .

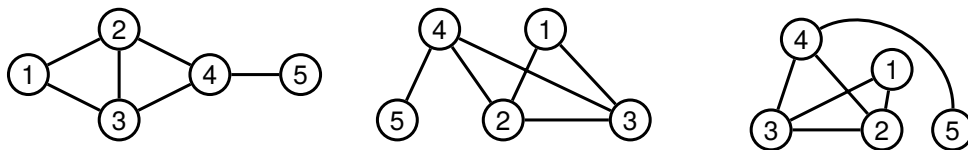
FIGURE 1: Three equivalent representations of the graph G

A function f with domain A and codomain B is written as $f: A \rightarrow B$. If $X \subseteq A$, the *restriction* of f to X is a function with domain X and codomain B , is denoted $f \upharpoonright X$, and is defined by $(f \upharpoonright X)(x) = f(x)$ for $x \in X$.

A (simple) graph G is a pair of sets $(\mathcal{V}, \mathcal{E})$ where \mathcal{V} is finite, and $\mathcal{E} \subseteq \binom{\mathcal{V}}{2}$, that is, \mathcal{E} is some subset of unordered pairs from \mathcal{V} . The elements of \mathcal{V} are called *vertices* or *nodes*, and the pairs in \mathcal{E} are called *edges*. We sometimes denote the sets \mathcal{V} and \mathcal{E} by $\mathcal{V}(G)$ and $\mathcal{E}(G)$, to show that they belong to the graph G . Typically, we take $\mathcal{V} = [n]$ for some $n \in \mathbb{N}$.

Example 0.1. Consider the graph G where $\mathcal{V}(G) = [5]$, and

$$\mathcal{E}(G) = \{\{1,2\}, \{1,3\}, \{2,3\}, \{2,4\}, \{3,4\}, \{4,5\}\}.$$

These two sets define a graph. The reason we call this pair of sets a ‘graph’ is because we like to associate with them a graphical representation consisting of dots (representing vertices in \mathcal{V}) connected by lines (which represent the edges in \mathcal{E}), as shown in [figure 1](#). ■

Unless stated otherwise, the number of vertices $|\mathcal{V}(G)|$ of a graph G will be denoted by the letter n , and the number of edges $|\mathcal{E}(G)|$ by the letter m .

Given a vertex $v \in \mathcal{V}$ in a graph G , the set of *neighbours* of v , denoted $N_G(v)$ or just $N(v)$, is the set

$$N(v) = \{u \in \mathcal{V} : \{u, v\} \in \mathcal{E}\}$$

of vertices joined to v by an edge. The number $|N(v)|$ of neighbours of $v \in \mathcal{V}$ is the *degree* of v in G , denoted $\deg_G(v)$ or simply $\deg(v)$.

Two graphs G and H are *isomorphic*, written $G \simeq H$, if H is simply G with its

vertices relabelled; i.e., if there exists a bijection $\pi: \mathcal{V}(G) \rightarrow \mathcal{V}(H)$ such that $\mathcal{V}(H) = \{\pi(v) : v \in \mathcal{V}(G)\}$ and

$$\mathcal{E}(H) = \{\{\pi(u), \pi(v)\} : \{u, v\} \in \mathcal{E}(G)\}.$$

A k -walk or *walk of length k* in a graph G is a $(k+1)$ -tuple $(v_0, \dots, v_k) \in \mathcal{V}^{k+1}$ such that $\{v_{i-1}, v_i\} \in \mathcal{E}$ for all $1 \leq i \leq k$, and a *walk* in G is simply any k -walk in G . For example, $(1, 2, 3, 4)$ and $(1, 2, 3, 2, 1)$ are walks in the graph of [figure 1](#), whereas $(1, 2, 3, 5)$ is not a walk. We also use the terminology “a walk from v_0 to v_k ” to describe (v_0, \dots, v_k) .

A walk (v_0, \dots, v_k) is said to be a *path* if in addition to being a walk, we have that v_0, \dots, v_k are all distinct.

A *subgraph* of a graph G is a graph H such that $\mathcal{V}(H) \subseteq \mathcal{V}(G)$ and $\mathcal{E}(H) \subseteq \mathcal{E}(G)$. Given any subset $\mathcal{U} \subseteq \mathcal{V}(G)$, then the *induced subgraph* on the vertices of \mathcal{U} is the subgraph H with $\mathcal{V}(H) = \mathcal{U}$ and $\mathcal{E}(H) = \mathcal{E}(G) \cap \binom{\mathcal{U}}{2}$. This subgraph H is usually denoted $G[\mathcal{U}]$ or $G \upharpoonright \mathcal{U}$.

A graph is said to be *connected* if for every pair of vertices $\{u, v\} \in \binom{\mathcal{V}}{2}$, there is a walk from u to v . Otherwise, we say the graph is *disconnected*. The largest subgraphs of a disconnected graph (with respect to number of vertices) which are connected are called the *components* of that graph. If a graph G has a k -walk (v_0, \dots, v_k) such that all v_0, \dots, v_{k-1} are distinct and $v_0 = v_k$, then this walk is said to be a k -*cycle* or simply a *cycle*. If k is odd or even, we use the terminology *odd (even) cycle*.

A graph is said to be *bipartite* if its vertex set \mathcal{V} can be split as $\mathcal{V} = \mathcal{V}_1 \cup \mathcal{V}_2$, where we call \mathcal{V}_1 and \mathcal{V}_2 the *partite sets*, such that $\mathcal{V}_1 \cap \mathcal{V}_2 = \emptyset$, and for all $\{u, v\} \in \mathcal{E}$, either $u \in \mathcal{V}_1$ and $v \in \mathcal{V}_2$ or $u \in \mathcal{V}_2$ and $v \in \mathcal{V}_1$. In other words, the vertex set \mathcal{V} can be split into two disjoint sets such that all edges in the graph are from one of these sets to the other.

We denote vectors in \mathbb{R}^n using the usual notation $\mathbf{v} = (v_i)$ or $(v_i)_n$, where $v_i: [n] \rightarrow \mathbb{R}$ denotes the general i th entry, and similarly for matrices we write $\mathbf{A} = (a_{ij})$ (or $(a_{ij})_{m \times n}$ when we wish to emphasise the dimensions),

where a_{ij} is the entry in the i th row and j th column, i.e., the ij th entry. The i th entry of a vector $v \in \mathbb{R}^n$ can be accessed using the notation $[v]_i$, and similarly the ij th entry of a matrix \mathbf{M} is denoted by $[\mathbf{M}]_{ij}$.

The all-ones vector $(1, \dots, 1) = (1)_n$ will be denoted by \mathbf{j} , and the all-ones matrix $(1)_{n \times n}$, i.e., the $n \times n$ matrix with ones everywhere, will be denoted by \mathbf{J} .

The *adjacency matrix* of a graph G , denoted $\mathbf{A}(G)$ or simply \mathbf{A} when the context is clear, is the symmetric $n \times n$ matrix (a_{ij}) , where

$$a_{ij} = \begin{cases} 1 & i, j \in \mathcal{E}(G) \\ 0 & \text{otherwise.} \end{cases}$$

We use terminology from linear algebra about a graph G in reference to its adjacency matrix \mathbf{A} . For example, the eigenvalues and eigenvectors of a graph G are respectively those of the matrix \mathbf{A} . If two graphs G and H have the same eigenvalues and multiplicities, then they are said to be *cospectral*.

Let V be a finite dimensional vector space with dimension n . We denote the eigenspace $\{v \in V : \mathbf{A}v = \lambda v\}$ of a matrix $\mathbf{A}: V \rightarrow V$ corresponding to the eigenvalue λ by $\mathcal{E}_{\mathbf{A}}(\lambda)$ or simply $\mathcal{E}(\lambda)$. If \mathbf{A} is the adjacency matrix of a graph G , we may also write $\mathcal{E}_G(\lambda)$.

The n -*cycle*, denoted C_n , is the graph $([n], \{\{i, i+1\} : i \in [n-1]\} \cup \{\{n, 1\}\})$, and the *complete graph on n vertices*, denoted K_n , is the graph $([n], \binom{[n]}{2})$.

Let G be a graph. The *complement* of G is another graph \bar{G} with the same vertex set $\mathcal{V}(\bar{G}) = \mathcal{V}(G)$, but complement edge set $\mathcal{E}(\bar{G}) = \binom{\mathcal{V}}{2} \setminus \mathcal{E}(G)$. In other words, $\{u, v\} \in \mathcal{E}(\bar{G})$ if and only if $\{u, v\} \notin \mathcal{E}(G)$, and vice-versa.

Let G_1, \dots, G_k be graphs. Then the *union* of G_1, \dots, G_k , denoted by $\bigcup_{i=1}^k G_i$ or $G_1 \cup \dots \cup G_k$, is the graph G with vertex set $\mathcal{V}(G) = \bigcup_{i=1}^k \mathcal{V}(G_i) \times \{i\}$ and edges $\mathcal{E}(G) = \bigcup_{i=1}^k \{\{(u, i), (v, i)\} : \{u, v\} \in \mathcal{E}(G_i)\}$. Clearly if a graph G is disconnected and has components G_1, \dots, G_k , then $G \simeq \bigcup_{i=1}^k G_i$. If one of the components is isomorphic to K_1 , then it is said to be an *isolated vertex*.

0.2 Some Basic Results

In this section we give proofs for some very straightforward results which will be assumed throughout the dissertation.

Proposition 0.2 (Handshaking Lemma). *Let $G = (\mathcal{V}, \mathcal{E})$ be a graph. Then*

$$\sum_{v \in \mathcal{V}} \deg(v) = 2|\mathcal{E}|.$$

Proof. By definition, $\deg v$ counts the number of edges incident to the vertex v . Therefore when summing all the degrees, each edge is counted once by each vertex to which it is incident. But every edge is incident to precisely two vertices, so each edge is counted twice, giving a total of $2|\mathcal{E}|$. \square

A more formal proof of the Handshaking lemma is by expressing $\deg(v)$ in terms of $N(v)$ and interchanging summations. This is the so-called *double counting* proof technique.

Proposition 0.3. *A graph is bipartite if and only if it contains no odd cycles.*

Proof. Suppose a graph G contains an odd cycle (v_0, \dots, v_{2k+1}) . If we try to partition the vertices of G into two partite sets \mathcal{V}_1 and \mathcal{V}_2 , then we have to place adjacent vertices in the cycle in separate sets. Without loss of generality, place v_0, v_2, \dots, v_{2k} in \mathcal{V}_1 , and $v_1, v_3, \dots, v_{2k-1}$ in \mathcal{V}_2 . But $v_{2k+1} = v_0$, so we cannot place it in \mathcal{V}_1 (since it is adjacent to v_{2k}) nor in \mathcal{V}_2 (since it is adjacent to v_1). Thus \mathcal{V} cannot be partitioned, and therefore G is not bipartite.

For the converse, first observe that if G is disconnected, and each component G_1, \dots, G_k is bipartite, each with partite sets \mathcal{U}_1 and \mathcal{U}'_1 , \mathcal{U}_2 and \mathcal{U}'_2 , \dots , \mathcal{U}_k and \mathcal{U}'_k , then $\mathcal{U} = \bigcup_{i=1}^k \mathcal{U}_i$ and $\mathcal{U}' = \bigcup_{i=1}^k \mathcal{U}'_i$ gives partite sets for G . Thus, it suffices to prove the converse for a connected graph.

Suppose G is connected and has no odd cycles. Pick a vertex $v \in \mathcal{V}(G)$. Define $N_0(v) = \{v\}$, $N_{k+1}(v) = \bigcup_{u \in N_k(v)} N_k(u)$, and consider the sets $\mathcal{V}_1 = \bigcup_{k=0}^n N_{2k}(v)$ and $\mathcal{V}_2 = \bigcup_{k=0}^n N_{2k+1}(v)$, where $n = |\mathcal{V}|$. Clearly since G is connected, $\mathcal{V}_1 \cup \mathcal{V}_2 = \mathcal{V}$. Now suppose two vertices $u, w \in \mathcal{V}_1$ are connected

by an edge. Being in \mathcal{V}_1 , there are distinct integers k, ℓ so that $u \in N_{2k}(v)$ and $w \in N_{2\ell}(v)$. Without loss of generality, say $k < \ell$. Then by the construction of the sets \mathcal{V}_1 and \mathcal{V}_2 , there is a path $(u = u_{2k}, u_{2k+1}, \dots, u_{2\ell} = w)$ where each $u_i \in N_i(v)$. But this path contains an odd number of vertices, and since u is joined to w , we get an odd cycle, which contradicts the hypothesis.

Thus no two vertices in \mathcal{V}_1 can be joined by an edge, and similarly for \mathcal{V}_2 . So G is bipartite. \square

Proposition 0.4. $\mathbf{A}(\bar{G}) = \mathbf{J} - \mathbf{I} - \mathbf{A}(G)$.

Proof. Let $\bar{a}_{ij} = [\mathbf{A}(\bar{G})]_{ij}$. Then the claim is $\bar{a}_{ij} = 1 - \delta_{ij} - a_{ij}$, where δ_{ij} is the Kronecker delta.¹ Clearly when $\{i, j\} \in \mathcal{E}$, the formula gives $\bar{a}_{ij} = 0$, whereas when $\{i, j\} \notin \mathcal{E}$, it gives $\bar{a}_{ij} = 1$, as desired. When $i = j$, $\{i, j\} = \{i\} \notin \binom{\mathcal{V}}{2}$, so we need the $-\delta_{ij}$ to make the diagonal zero. \square

Proposition 0.5.

$$\mathbf{A}(G_1 \cup \dots \cup G_k) = \begin{pmatrix} \mathbf{A}(G_1) & & \mathbf{O} \\ & \ddots & \\ \mathbf{O} & & \mathbf{A}(G_k) \end{pmatrix}$$

Proof. We prove the case $k = 2$, the general case follows by induction. If G_1 has n_1 vertices and G_2 has n_2 vertices, then $G_1 \cup G_2$ has $n_1 + n_2$ vertices, labelled $(1, 1), \dots, (n_1, 1), (1, 2), \dots, (n_2, 2)$ by definition.

Clearly the adjacencies between $(1, 1), \dots, (n_1, 1)$ are the same as those of G_1 , and the adjacencies between $(1, 2), \dots, (n_2, 2)$ are the same as those of G_2 . There is no edge of the form $\{(u, 1), (v, 2)\}$. Hence the adjacency matrix is

$$\mathbf{A}(G_1 \cup G_2) = \begin{pmatrix} \mathbf{A}(G_1) & \mathbf{O} \\ \mathbf{O} & \mathbf{A}(G_2) \end{pmatrix},$$

as required. \square

¹ $\delta_{ij} = 1$ if $i = j$, and 0 otherwise. This is the ij th entry of \mathbf{I} .

0.3 Document Structure

In the first chapter, we give some preliminary results, mostly about linear algebra, which the reader might not have come across in typical/standard treatments. In particular, the results are aimed to be used with the adjacency matrix of a graph. The chapter ends with a result on polynomials which will be utilised in the following chapter.

The second chapter introduces the ideas of main eigenvectors, main eigenvalues, main polynomials, and main eigenspaces. The number of walks N_k of length k is expressed solely in terms of the main angles and main eigenvalues of a graph. Generating functions for N_k are derived, and the main polynomial $m_G(x)$ is shown to have integer coefficients. These concepts are then applied to obtain results on walk matrices.

In the third chapter, canonical double covers are introduced and some standard facts are proven about them. Some original results are presented in this chapter, in particular the proofs of [theorem 3.4](#) and the hierarchical results of [section 3.3](#).

Finally in [appendix A](#), a list of all pairs of non-isomorphic graphs on $n \leq 8$ vertices having the same canonical double cover is presented.

Preliminary Matrix Theory

"We think basis-free, we write basis-free, but when the chips are down, we close the office door and compute with matrices like fury."

IRVING KAPLANSKY

In this chapter, we provide proofs of some fairly common algebraic results which concern symmetric $(0, 1)$ -matrices.

1.1 Permutation Matrices

First we go to the notion of a permutation matrix. These are matrices whose columns are simply permutations of the columns of the identity matrix. We define them as follows.

Definition 1.1 (Permutation Matrix). A square matrix $\mathbf{P} = (p_{ij})$ is said to be a *permutation matrix* if each row and column contains precisely one 1, and the remaining entries are zero.

More precisely, for each fixed i , there is precisely one $j = j'$ such that $p_{ij'} = 1$, and $p_{ij} = 0$ otherwise. Similarly, for each fixed j , there is precisely one $i = i'$ such that $p_{i'j} = 1$, and $p_{ij} = 0$ otherwise. ■

Using a pigeonhole argument, one can easily see that permutation matrices correspond to permutations of the columns of the identity. Indeed, there is a natural correspondence: any permutation $\pi: [n] \rightarrow [n]$ of the numbers $1, \dots, n$ corresponds to the permutation matrix $\mathbf{P}_\pi = (p_{ij})$, where $p_{ij} = 1$

if $\pi(i) = j$, and $p_{ij} = 0$ otherwise. Consequently, the number of $n \times n$ permutation matrices is $n!$.

A basic fact about permutation matrix is that they are orthogonal:

Proposition 1.2. *Let \mathbf{P} be a permutation matrix. Then $\mathbf{P}\mathbf{P}^\top = \mathbf{I}$.*

Proof. If $\mathbf{P} = (p_{ij})_{n \times n}$, then

$$[\mathbf{P}\mathbf{P}^\top]_{ij} = \sum_{k=1}^n p_{ki}p_{kj} = \begin{cases} 1 & \text{if } i = j \\ 0 & \text{otherwise,} \end{cases}$$

as required. □

Moreover, permutation matrices are the only orthogonal matrices having non-negative entries:

Proposition 1.3. *Let $\mathbf{P} = (p_{ij})$ be an $n \times n$ matrix with $p_{ij} \geq 0$ for all $i, j \in [n]$ and $\mathbf{P}\mathbf{P}^\top = \mathbf{I}$. Then \mathbf{P} is a permutation matrix.*

Proof. Each row and column of \mathbf{P} must contain at least one non-zero entry, otherwise $\mathbf{P}\mathbf{P}^\top \neq \mathbf{I}$ since the product will have a row/column of zeros.

Now suppose two entries of \mathbf{P} in the i th row are non-zero, say p_{ij} and $p_{ij'}$ where $j \neq j'$. But then the entry in the jj' th position in $\mathbf{P}\mathbf{P}^\top$ will not be zero, a contradiction. A similar argument yields the corresponding fact for columns.

Finally, suppose one of the non-zero entries of \mathbf{P} is not equal to 1, say in the ij th position. Then the entry in the jj th position of $\mathbf{P}\mathbf{P}^\top$ is $\sum_{k=1}^n p_{kj}^2 = p_{ij}^2 \neq 1$, a contradiction. □

Remark 1.4 (Birkhoff–von Neumann). A famous result about permutation matrices is the so-called Birkhoff–von Neumann theorem.

A matrix $\mathbf{A} = (a_{ij})$ is said to be doubly stochastic if the sum of each row and column is 1, i.e., if for all i and for all j , we have $\sum_{k=1}^n a_{ik} = \sum_{k=1}^n a_{kj} = 1$.

Such matrices are of interest in probability theory, particularly when representing Markov chains.

Clearly all permutations are doubly stochastic. Moreover, according to the theorem: every $n \times n$ doubly stochastic matrix may be written as a convex combination of the $n!$ different $n \times n$ permutation matrices $\mathbf{P}_1, \dots, \mathbf{P}_{n!}$. In other words, if \mathbf{A} is doubly stochastic, then there exist $\alpha_1, \dots, \alpha_{n!} \in \mathbb{R}$ with $\alpha_1 + \dots + \alpha_{n!} = 1$ so that we may decompose \mathbf{A} as

$$\mathbf{A} = \alpha_1 \mathbf{P}_1 + \dots + \alpha_{n!} \mathbf{P}_{n!}.$$

Even though there are potentially $n!$ terms in such a decomposition, it has been shown that there are never more than $(n - 1)^2 + 1$ terms necessary, although determining the minimal expansion is NP-hard.^[12]

We only mention this theorem here, but do not provide a proof, as we will not be making use of it in later chapters. ■

Now we go to perhaps the most important use of permutation matrices as far as we are concerned—they provide us with an equivalent formulation of the notion of graph isomorphism.

Proposition 1.5. *Let G and H be two graphs having adjacency matrices $\mathbf{A}_G = (g_{ij})$ and $\mathbf{A}_H = (h_{ij})$ respectively. Then $G \simeq H$ if and only if there exists a permutation matrix \mathbf{P} such that $\mathbf{P}^T \mathbf{A}_G \mathbf{P} = \mathbf{A}_H$.*

Proof. Suppose G and H are isomorphic, i.e., there is a bijection $\pi: \mathcal{V}(G) \rightarrow \mathcal{V}(H)$ such that $\{u, v\} \in \mathcal{E}(G)$ if and only if $\{\pi(u), \pi(v)\} \in \mathcal{E}(H)$. Define the $n \times n$ matrix $\mathbf{P} = (p_{ij})$ by

$$p_{ij} = \begin{cases} 1 & \text{if } \pi(i) = j \\ 0 & \text{otherwise,} \end{cases}$$

i.e., there is a 1 in row i and column j if vertex i in G is relabelled to j in H , and a 0 otherwise. Since π is a bijection, fixing i , one has that p_{ij} can only be 1 for a single value of j and 0 otherwise; similarly if j is fixed, there is only

one value of i such that $p_{ij} = 1$. Thus each row and column of \mathbf{P} contains precisely one 1, making it a permutation matrix.

Now by matrix multiplication, the ij th entry of $\mathbf{P}^T \mathbf{A}_G \mathbf{P}$ is

$$\sum_{k=1}^n \sum_{\ell=1}^n p_{ki} g_{k\ell} p_{\ell j} = p_{ui} g_{uv} p_{vj},$$

since by definition of p_{ij} and g_{ij} , the terms in this double sum can only be non-zero if there are $u, v \in \mathcal{V}(G)$ such that $\pi(u) = i$, $\{u, v\} \in \mathcal{E}(G)$, and $\pi(v) = j$; which is true if and only if $\{\pi(u), \pi(v)\} = \{i, j\} \in \mathcal{E}(H)$. In other words,

$$\sum_{k=1}^n \sum_{\ell=1}^n p_{ki} g_{k\ell} p_{\ell j} = \begin{cases} 1 & \text{if } \{i, j\} \in \mathcal{E}(H) \\ 0 & \text{otherwise} \end{cases} = h_{ij},$$

and so $\mathbf{P}^T \mathbf{A}_G \mathbf{P} = (h_{ij}) = \mathbf{A}_H$.

Conversely, suppose $\mathbf{P} = (p_{ij})$ is a permutation matrix such that $\mathbf{P}^T \mathbf{A}_G \mathbf{P} = \mathbf{A}_H$, and define

$$\pi = \{i \mapsto j : p_{ij} = 1\}.$$

Clearly π is a bijection from $\mathcal{V}(G)$ to $\mathcal{V}(H)$, since for each i there is a j such that $p_{ij} = 1$, and vice-versa. Moreover,

$$\begin{aligned} \{u, v\} \in \mathcal{E}(G) &\iff g_{uv} = 1 \\ &\iff p_{ui} g_{uv} p_{vj} = 1 \quad (\text{where } \pi(i) = u, \pi(j) = v) \\ &\iff p_{ui} g_{uv} p_{vj} + 0 = 1 \\ &\iff p_{ui} g_{uv} p_{vj} + \sum_{\substack{k=1 \\ k \neq u}}^n \sum_{\substack{\ell=1 \\ \ell \neq v}}^n p_{ki} g_{k\ell} p_{\ell j} = 1 \\ &\iff \sum_{k=1}^n \sum_{\ell=1}^n p_{ki} g_{k\ell} p_{\ell j} = 1 \\ &\iff h_{ij} = 1 \iff \{i, j\} = \{\pi(u), \pi(v)\} \in \mathcal{E}(H), \end{aligned}$$

i.e., $G \simeq H$, as required. □

An immediate consequence of this result is the following.

Corollary 1.6. *Let G and H be isomorphic graphs. Then G and H have the same:*

- | | |
|---------------------------------|-------------------------------------|
| (i) rank, | (iv) trace, |
| (ii) characteristic polynomial, | (v) eigenvalues and multiplicities, |
| (iii) determinant, | (vi) minimum polynomial. |

Proof. Since $G \simeq H$, then there is a permutation matrix \mathbf{P} such that $\mathbf{P}^T \mathbf{A}_G \mathbf{P} = \mathbf{A}_H$. Moreover, since \mathbf{P} is a permutation matrix, then by **proposition 1.2** $\mathbf{P}^T = \mathbf{P}^{-1}$, so in fact $\mathbf{P}^{-1} \mathbf{A}_G \mathbf{P} = \mathbf{A}_H$. Hence the adjacency matrices are similar, and thus properties (i)–(vi) follow immediately by usual linear algebra theory on similar matrices. \square

Therefore, since isomorphic graphs have many properties in common, we will not give importance to the labelling of the vertices, and omit vertex numbering in future figures and examples (unless it makes a difference to our considerations).

1.2 Spectral Results

Some important facts about eigenvalues and eigenvectors are more fruitful when we restrict our considerations to adjacency matrices of graphs.

Suppose $V = V(\mathbb{C})$ is a complex vector space of finite dimension with basis $\{\mathbf{b}_1, \dots, \mathbf{b}_n\}$. Then $\langle \cdot, \cdot \rangle: V \times V \rightarrow \mathbb{R}$ defined by $\langle \mathbf{x}, \mathbf{y} \rangle = \mathbf{x}^T \bar{\mathbf{y}}$, where the bar denotes complex conjugation, defines an inner product on V ; that is, the following properties hold:

- | | | |
|-------|--|--|
| (i) | $\langle \mathbf{x} + \mathbf{y}, \mathbf{z} \rangle = \langle \mathbf{x}, \mathbf{z} \rangle + \langle \mathbf{y}, \mathbf{z} \rangle$, and
$\langle \lambda \mathbf{x}, \mathbf{y} \rangle = \lambda \langle \mathbf{x}, \mathbf{y} \rangle$, | (LINEARITY IN THE
FIRST COORDINATE) |
| (ii) | $\langle \mathbf{x}, \mathbf{y} \rangle = \overline{\langle \mathbf{y}, \mathbf{x} \rangle}$, | (CONJUGATE SYMMETRY) |
| (iii) | $\langle \mathbf{x}, \mathbf{x} \rangle \geq 0$, and $\langle \mathbf{x}, \mathbf{x} \rangle = 0 \iff \mathbf{x} = \mathbf{0}$. | (POSITIVITY) |

An operator $\mathbf{A}: V \rightarrow V$ is *Hermitian* if for all $\mathbf{x}, \mathbf{y} \in V$, $\langle \mathbf{A}\mathbf{x}, \mathbf{y} \rangle = \langle \mathbf{x}, \mathbf{A}\mathbf{y} \rangle$.

Proposition 1.7. *Let $\mathbf{A}: V \rightarrow V$ be an operator. Then \mathbf{A} is Hermitian if and only if $\mathbf{A} = \bar{\mathbf{A}}^\top$.*

Proof. Suppose \mathbf{A} Hermitian. Then

$$a_{ij} = \langle \mathbf{A}b_i, b_j \rangle = \langle b_i, \mathbf{A}b_j \rangle = \overline{\langle \mathbf{A}b_j, b_i \rangle} = \bar{a}_{ji},$$

so $\mathbf{A} = \bar{\mathbf{A}}^\top$. Conversely, suppose $\bar{\mathbf{A}}^\top = \mathbf{A}$. Thus for any $x, y \in V$,

$$\langle \mathbf{A}x, y \rangle = \overline{\mathbf{A}x}^\top y = \bar{x}^\top \bar{\mathbf{A}}^\top y = \bar{x}^\top \mathbf{A}y = \langle x, \mathbf{A}y \rangle,$$

thus \mathbf{A} is Hermitian, as required. □

Since the adjacency matrix of a graph is real and symmetric, it follows that it is a Hermitian operator.

1.2.1 Orthogonal Projections

Now we take a look at orthogonal projections, which help us obtain the spectral decomposition of an operator.

Definition 1.8 (Orthogonal Projection). The *orthogonal projection of v onto u* , where $u, v \in \mathbb{R}^n$, $u \neq \mathbf{0}$, denoted $\mathbf{P}_u(v)$, is the vector given by

$$\mathbf{P}_u(v) = \frac{\langle v, u \rangle}{\|u\|^2} u.$$

More generally, the orthogonal projection of v onto a subspace $U \leq V$, denoted $\mathbf{P}_U(v)$, is the vector

$$\mathbf{P}_U(v) = \sum_{i=1}^r \mathbf{P}_{u_i}(v),$$

where $\{u_1, u_2, \dots, u_r\}$ is an orthonormal basis for U . ■

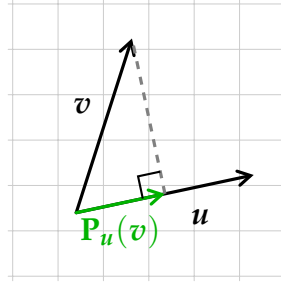
FIGURE 1.1: Illustration of **definition 1.8** in \mathbb{R}^2 .

Even though we define the orthogonal projection $\mathbf{P}_U: V \rightarrow U$ in terms of some orthonormal basis of U , it is in fact independent of which orthonormal basis is chosen. This follows from the following fact.

Proposition 1.9. *Let $U \leq V$ be a subspace, and let $v \in V$. Then $\mathbf{P}_U(v)$ is the unique $u \in U$ such that $\langle v - u, x \rangle = 0$ for all $x \in U$.*

Proof. Fix an orthonormal basis $\{u_1, \dots, u_r\}$ for U . Clearly for any u_j ,

$$\begin{aligned} \langle v - \mathbf{P}_U(v), u_j \rangle &= \left\langle v - \sum_{i=1}^r \frac{\langle v, u_i \rangle}{\|u_i\|^2} u_i, u_j \right\rangle \\ &= \langle v, u_j \rangle - \sum_{i=1}^r \frac{\langle v, u_i \rangle}{\|u_i\|^2} \langle u_i, u_j \rangle \\ &= \langle v, u_j \rangle - \langle v, u_j \rangle - \sum_{i \neq j} \frac{\langle v, u_i \rangle}{\|u_i\|^2} \underbrace{\langle u_i, u_j \rangle}_{=0} \\ &= 0, \end{aligned}$$

and hence for any vector $\sum_{i=1}^r \alpha_i u_i$ in U , we have

$$\left\langle v - \mathbf{P}_U(v), \sum_{i=1}^r \alpha_i u_i \right\rangle = \sum_{i=1}^r \alpha_i \langle v - \mathbf{P}_U(v), u_i \rangle = 0.$$

Now to show that there is only one vector with this property, suppose there are two vectors u, u' such that for any $x \in U$, $\langle v - u, x \rangle = \langle v - u', x \rangle = 0$.

Then for any $x \in U$,

$$\begin{aligned}
 & \langle v - u, x \rangle - \langle v - u', x \rangle = 0 \\
 \implies & \langle (v - u) - (v - u'), x \rangle = 0 \\
 \implies & \langle u - u', x \rangle = 0 \\
 \implies & \langle u - u', u - u' \rangle = 0 \quad \text{since } u - u' \in U \\
 \implies & u = u'. \quad \square
 \end{aligned}$$

Since the projection of v onto U is the unique vector satisfying the property of [proposition 1.9](#), then the orthonormal basis chosen does not make a difference.

A nice property about projections is their idempotency.

Proposition 1.10. *Let $U \leq V$ be a subspace. Then $\mathbf{P}_U^2 = \mathbf{P}_U$.*

Proof. Let $v \in V$. By [proposition 1.9](#), the projection $u = \mathbf{P}_U(v)$ is the unique $u \in U$ such that $\langle v - u, x \rangle = 0$ for all $x \in U$. Similarly, $u' = \mathbf{P}_U(u) = \mathbf{P}_U^2(v)$ is the unique $u' \in U$ such that $\langle u - u', x \rangle = 0$.

But $\langle u - u', x \rangle = 0 \implies \langle u, x \rangle = \langle u', x \rangle$ for all x . It follows that $u = u'$, i.e., that $\mathbf{P}_U(u) = \mathbf{P}_U^2(v)$. \square

Another useful property of projections is the following.

Proposition 1.11. *Let $\mathbf{P}_U: V \rightarrow U$ be a projection, and let $B_V = \{\mathbf{b}_1, \dots, \mathbf{b}_n\}$ be an orthonormal basis for V , a subset B_U of which forms a basis for U . With respect to this basis, \mathbf{P}_U has matrix representation*

$$\mathbf{P}_U = \begin{pmatrix} e_1 & 0 & \cdots & 0 \\ 0 & e_2 & \cdots & 0 \\ \vdots & \vdots & \ddots & \vdots \\ 0 & 0 & \cdots & e_n \end{pmatrix}$$

where $e_i = 1$ if $\mathbf{b}_i \in B_U$, and $e_i = 0$ otherwise.

Proof. Let $\mathbf{v} = \alpha_1 \mathbf{b}_1 + \cdots + \alpha_n \mathbf{b}_n \in V$. Then

$$\begin{aligned} \mathbf{P}_U(\mathbf{v}) &= \sum_{\mathbf{b} \in B_U} \frac{\langle \mathbf{v}, \mathbf{b} \rangle}{\|\mathbf{b}\|^2} \mathbf{b} = \sum_{i=1}^n \sum_{j=1}^n \alpha_j e_i \underbrace{\langle \mathbf{b}_j, \mathbf{b}_i \rangle}_{=0 \text{ unless } \mathbf{b}_i = \mathbf{b}_j} \mathbf{b}_i = \sum_{i=1}^n \alpha_i e_i \mathbf{b}_i \\ &= \begin{pmatrix} e_1 & 0 & \cdots & 0 \\ 0 & e_2 & \cdots & 0 \\ \vdots & \vdots & \ddots & \vdots \\ 0 & 0 & \cdots & e_n \end{pmatrix} \begin{pmatrix} \alpha_1 \\ \alpha_2 \\ \vdots \\ \alpha_n \end{pmatrix}, \end{aligned}$$

as required. □

As a consequence of this matrix representation, we have the following easy corollaries.

Corollary 1.12. *Suppose $V = \bigoplus_{i=1}^s U_i$. Then*

$$\sum_{i=1}^s \mathbf{P}_{U_i} = \mathbf{I}.$$

Proof. $B = \bigcup_{i=1}^s B_{U_i}$ is an orthonormal basis for V , where B_{U_i} is an orthonormal basis for each U_i . The matrix representation of each \mathbf{P}_{U_i} is as in **proposition 1.11**. Any overlap of diagonal entries amongst the \mathbf{P}_{U_i} 's contradicts that the sum is direct, whereas any diagonal entry left out contradicts that B spans V . □

Corollary 1.13. *Let $\mathbf{P}_U: V \rightarrow U$ be an orthogonal projection. Then*

$$\mathbf{P}_U \mathbf{P}_U^T = \mathbf{P}_U = \mathbf{I} \upharpoonright U.$$

1.2.2 The Spectral Theorem

Now we go to the spectral theorem, an important result which illustrates a lot of the nice properties of Hermitian operators. In particular, it allows us to decompose them as a sum of projections onto their eigenspaces.

Theorem 1.14 (Spectral Theorem). *Let $\mathbf{A}: V \rightarrow V$ be a Hermitian operator with distinct eigenvalues μ_1, \dots, μ_s . Then:*

- (i) *Each eigenvalue μ of \mathbf{A} is real,*
- (ii) *There is an orthonormal basis for V consisting solely of eigenvectors of \mathbf{A} . Consequently $V = \bigoplus_{i=1}^s \mathcal{E}_{\mathbf{A}}(\mu_i)$,*
- (iii) *\mathbf{A} may be written as*

$$\mathbf{A} = \mu_1 \mathbf{P}_1 + \dots + \mu_s \mathbf{P}_s$$

where $\mathbf{P}_i: V \rightarrow \mathcal{E}_{\mathbf{A}}(\mu_i)$ is the orthogonal projection onto the eigenspace corresponding to μ_i .

Proof. For (i), if $v \neq 0$ and $\mathbf{A}v = \mu v$, then

$$\mu \|v\|^2 = \langle \mu v, v \rangle = \langle \mathbf{A}v, v \rangle = \langle v, \mathbf{A}v \rangle = \langle v, \mu v \rangle = \overline{\langle \mu v, v \rangle} = \bar{\mu} \|v\|^2,$$

so $\mu = \bar{\mu}$, i.e., μ is real.

For (ii), we proceed by induction on $\dim V$. If V is of dimension zero, then the empty set is a basis for V and $V = \{0\}$ is the result of an empty direct sum.

Suppose $\dim V \geq 1$. By the fundamental theorem of algebra, the characteristic polynomial of \mathbf{A} has a root μ and a corresponding unit eigenvector v . Moreover by (i) above, μ is real.

Now consider the space $U = \{v\}^\perp$, and note that for all $u \in U$,

$$\langle \mathbf{A}u, v \rangle = \langle u, \mathbf{A}v \rangle = \langle u, \mu v \rangle = \bar{\mu} \langle u, v \rangle = 0,$$

so $\mathbf{A}u \in U$, i.e., U is \mathbf{A} -invariant. Since $V = U \oplus U^\perp$ and $\dim U^\perp = 1$, it follows that $\dim V = \dim U + 1 > \dim U$, so we may apply the inductive hypothesis to get an orthonormal basis B for U in terms of eigenvectors of $\mathbf{A} \upharpoonright U$. $B \cup \{v\}$ gives the required basis.

Since each eigenvector of in $B \cup \{v\}$ is in its eigenspace, and by **proposi-**

tion 1.17 below, eigenvectors from different eigenspaces are independent and orthogonal, it follows that $V = \bigoplus_{i=1}^s \mathcal{E}_{\mathbf{A}}(\mu_i)$.

Finally for (iii), we know that the matrix representation of \mathbf{A} in terms of a basis of eigenvectors is diagonal. By (ii) above, \mathbf{A} has such a basis, so we can write

$$\mathbf{A} = \begin{pmatrix} \begin{array}{c|c} \mu_1 & \mathbf{O} \\ \hline & \mu_1 \end{array} & & \\ & \ddots & \\ \mathbf{O} & & \begin{array}{c|c} \mu_s & \\ \hline & \mu_s \end{array} \end{pmatrix}$$

where μ_1, \dots, μ_s are the distinct eigenvalues of \mathbf{A} , each appearing $m(\mu_i)$ times, where $m(\mu_i)$ is the multiplicity of μ_i in the characteristic polynomial $\phi_{\mathbf{A}}$. Hence

$$\begin{aligned} \mathbf{A} &= \mu_1 \begin{pmatrix} \begin{array}{c|c} 1 & \mathbf{O} \\ \hline & 1 \end{array} & & \\ & \ddots & \\ \mathbf{O} & & \mathbf{O} \end{pmatrix} + \dots + \mu_s \begin{pmatrix} \mathbf{O} & & \mathbf{O} \\ & \ddots & \\ \mathbf{O} & & \begin{array}{c|c} 1 & \\ \hline & 1 \end{array} \end{pmatrix} \\ &= \mu_1 \mathbf{P}_1 + \dots + \mu_s \mathbf{P}_s \end{aligned}$$

by proposition 1.11. □

Example 1.15. Suppose

$$\mathbf{A} = \begin{pmatrix} 1 & 1 & 4 \\ 1 & 1 & 4 \\ 4 & 4 & -2 \end{pmatrix}.$$

Then $\phi_{\mathbf{A}}(\lambda) = \lambda^3 - 36\lambda$, so the eigenvalues of \mathbf{A} are 0 and ± 6 . Moreover, the corresponding orthonormal eigenvectors of \mathbf{A} are the columns of the transition matrix

$$\mathbf{P} = \begin{pmatrix} -\frac{1}{\sqrt{2}} & \frac{1}{\sqrt{3}} & -\frac{1}{\sqrt{6}} \\ \frac{1}{\sqrt{2}} & \frac{1}{\sqrt{3}} & -\frac{1}{\sqrt{6}} \\ 0 & \frac{1}{\sqrt{3}} & \frac{2}{\sqrt{6}} \end{pmatrix}.$$

With respect to this basis, \mathbf{A} may be written as

$$\begin{aligned}\mathbf{A} &= \begin{pmatrix} 0 & 0 & 0 \\ 0 & 6 & 0 \\ 0 & 0 & -6 \end{pmatrix} = 0 \begin{pmatrix} 1 & 0 & 0 \\ 0 & 0 & 0 \\ 0 & 0 & 0 \end{pmatrix} + 6 \begin{pmatrix} 0 & 0 & 0 \\ 0 & 1 & 0 \\ 0 & 0 & 0 \end{pmatrix} + -6 \begin{pmatrix} 0 & 0 & 0 \\ 0 & 0 & 0 \\ 0 & 0 & 1 \end{pmatrix} \\ &= 0\mathbf{P}_{\mathcal{E}(0)} + 6\mathbf{P}_{\mathcal{E}(6)} - 6\mathbf{P}_{\mathcal{E}(-6)},\end{aligned}$$

or, with respect to the standard basis,

$$\mathbf{A} = 0 \begin{pmatrix} \frac{1}{2} & -\frac{1}{2} & 0 \\ -\frac{1}{2} & \frac{1}{2} & 0 \\ 0 & 0 & 0 \end{pmatrix} + 6 \begin{pmatrix} \frac{1}{3} & \frac{1}{3} & \frac{1}{3} \\ \frac{1}{3} & \frac{1}{3} & \frac{1}{3} \\ \frac{1}{3} & \frac{1}{3} & \frac{1}{3} \end{pmatrix} + -6 \begin{pmatrix} \frac{1}{6} & \frac{1}{6} & -\frac{1}{3} \\ \frac{1}{6} & \frac{1}{6} & -\frac{1}{3} \\ -\frac{1}{3} & -\frac{1}{3} & \frac{2}{3} \end{pmatrix}.$$

■

As a consequence, we immediately get the following.

Corollary 1.16. *Let G be a graph with $|\mathcal{V}(G)| = n$. Then \mathbb{R}^n has a basis in terms of the eigenvectors of G .*

Proof. The adjacency matrix of a graph is a linear operator $\mathbf{A}: \mathbb{R}^n \rightarrow \mathbb{R}^n$. Moreover, the adjacency matrix of a graph is symmetric, so by **the spectral theorem** the result follows. \square

We will also find the following fact useful.

Proposition 1.17. *If $\mathbf{A}: V \rightarrow V$ is Hermitian, then any eigenvectors belonging to distinct eigenvalues are linearly independent and orthogonal.*

Proof. Suppose $\mathbf{A}\mathbf{x} = \lambda\mathbf{x}$ and $\mathbf{A}\mathbf{y} = \mu\mathbf{y}$ where $\lambda \neq \mu$ and $\mathbf{x} \neq \mathbf{0} \neq \mathbf{y}$.

We do not need the Hermitian property for independence, indeed, suppose $a\mathbf{x} + b\mathbf{y} = \mathbf{0}$. Then

$$\mathbf{0} = \mathbf{A}\mathbf{0} = \mathbf{A}(a\mathbf{x} + b\mathbf{y}) = a\lambda\mathbf{x} + b\mu\mathbf{y} \tag{1.1}$$

Moreover, $ax + by = \mathbf{0} \implies a\lambda x + b\lambda y = \mathbf{0}$. Subtracting this from (1.1), we get $(\lambda - \mu)ax = \mathbf{0}$. Since λ and μ are different and $x \neq \mathbf{0}$, we must have that $a = 0$. Multiplying $ax + by = \mathbf{0}$ by μ instead similarly yields that $b = 0$, as required.

Now for orthogonality, observe that

$$\begin{aligned} (\lambda - \bar{\mu})\langle x, y \rangle &= \langle \lambda x, y \rangle - \langle x, \mu y \rangle = \langle \mathbf{A}x, y \rangle - \langle x, \mathbf{A}y \rangle \\ &= \langle \mathbf{A}x, y \rangle - \langle \mathbf{A}x, y \rangle = 0, \end{aligned}$$

and since $\lambda \neq \mu = \bar{\mu}$ (eigenvalues are real by **the spectral theorem**), then it follows that $\langle x, y \rangle = 0$. \square

1.3 Number of Walks

Theorem 1.18. *Let G be a graph with adjacency matrix \mathbf{A} . The number of walks of length k from vertex i to vertex j is the ij th entry of \mathbf{A}^k .*

Proof. By induction on k . Let $W_{ij}(k)$ denote the set of walks of length k from i to j . For the base case,

$$\begin{aligned} W_{ij}(1) &= \{(v_0, v_1) : \{v_0, v_1\} \in \mathcal{E}, v_0 = i \text{ and } v_1 = j\} \\ &= \begin{cases} \{(i, j)\} & \text{if } \{i, j\} \in \mathcal{E} \\ \emptyset & \text{otherwise,} \end{cases} \end{aligned}$$

so $|W_{ij}(1)| = 1$ if $\{i, j\} \in \mathcal{E}$ and 0 otherwise, i.e., $|W_{ij}(1)| = a_{ij} = [\mathbf{A}^1]_{ij}$.

Now let $k \geq 1$. Then

$$\begin{aligned} W_{ij}(k) &= \{(v_0, \dots, v_k) : \{v_{i-1}, v_i\} \in \mathcal{E} \text{ for } 1 \leq i \leq k, v_0 = i \text{ and } v_k = j\} \\ &= \{(v_0, \dots, \ell, j) : (v_0, \dots, \ell) \in W_{i\ell}(k-1) \text{ and } \ell \in N(j)\} \\ &= \bigcup_{\ell \in N(j)} \{(v_0, \dots, \ell, j) : (v_0, \dots, \ell) \in W_{i\ell}(k-1)\} \end{aligned}$$

and consequently,

$$\begin{aligned}
 |W_{ij}(k)| &= \sum_{\ell \in N(j)} |\{(v_0, \dots, \ell, j) : (v_0, \dots, \ell) \in W_{i\ell}(k-1)\}| \\
 &= \sum_{\ell=1}^n a_{\ell j} |\{(v_0, \dots, \ell, j) : (v_0, \dots, \ell) \in W_{i\ell}(k-1)\}| \\
 &= \sum_{\ell=1}^n a_{\ell j} |W_{i\ell}(k-1)| = \sum_{\ell=1}^n [\mathbf{A}^{k-1}]_{i\ell} a_{\ell j} = [\mathbf{A}^k]_{ij},
 \end{aligned}$$

by the induction hypothesis. \square

Corollary 1.19. *The number of walks of length k starting from vertex i is the i th entry of $\mathbf{A}^k \mathbf{j}$.*

Proof. Let $W_{ij}(k)$ be as in the proof of [theorem 1.18](#). The number of walks of length k from vertex i is then

$$\left| \bigcup_{j \in \mathcal{V}} W_{ij}(k) \right| = \sum_{j \in \mathcal{V}} |W_{ij}(k)| = \sum_{j \in \mathcal{V}} [\mathbf{A}^k]_{ij} = \sum_{j=1}^n [\mathbf{A}^k]_{ij} 1 = [\mathbf{A}^k \mathbf{j}]_i,$$

as required. \square

Corollary 1.20. *Let G be a graph with adjacency matrix \mathbf{A} , having e edges and t triangles. Then*

- (i) $\text{tr } \mathbf{A} = 0$,
- (ii) $\text{tr } \mathbf{A}^2 = 2e$,
- (iii) $\text{tr } \mathbf{A}^3 = 6t$.

Proof. (i) follows by definition of \mathbf{A} . For (ii), observe that the entries on the diagonal of \mathbf{A}^2 are those walks of length 2 from a vertex to itself. At each vertex v , there are $\deg v$ such walks, namely (v, n, v) for $n \in N(v)$. Thus $\text{tr } \mathbf{A}^2 = \sum_{v \in \mathcal{V}} \deg v = 2e$ by [the handshaking lemma](#).

Finally for (iii), observe that each walk of length 3 from a vertex u to itself, (u, v, w, u) , corresponds to a triangle. However each triangle is counted six times: indeed, (u, v, w, u) , (u, w, v, u) , (v, u, w, v) , (v, w, u, v) , (w, u, v, w) and (w, v, u, w) all correspond to the same triangle $\{u, v, w\}$. Thus $\text{tr } \mathbf{A}^3 = \sum_{v \in \mathcal{V}} [\mathbf{A}^3]_{ii} = 6t$. \square

Since the trace of a matrix is the sum of eigenvalues, then the spectrum of a graph determines the number of vertices, edges and triangles. It is difficult to generalise [corollary 1.20](#), as $K_{1,4}$ and $K_1 \cup C_4$ are cospectral yet they do not have the same number of 4-cycles.

1.4 Gauss' Lemma

We conclude this chapter with a useful result on polynomials. $\mathbb{Z}[x]$ and $\mathbb{Q}[x]$ denote the rings of polynomials over the integers and the rationals respectively. Reference was made to [9] for the results in this section.

Definitions 1.21 (Polynomial Terminology). The *content* of a polynomial $p = a_0 + a_1x + \cdots + a_nx^n \in \mathbb{Z}[x]$ is the greatest common divisor of its coefficients a_i .

A polynomial is said to be *primitive* if its content is 1. \blacksquare

Clearly any polynomial $p \in \mathbb{Z}[x]$ with content c can be written as $cq(x)$ where q is primitive.

Lemma 1.22. *Let $p, q \in \mathbb{Z}[x]$ be primitive polynomials. Then the product pq is primitive.*

Proof. Let $p = a_0 + \cdots + a_nx^n$ and $q = b_0 + \cdots + b_mx^m$, and for contradiction, suppose that pq has content $c \neq 1$. In particular, c has some prime factor d . Since p and q are primitive, then d does not divide at least one coefficient of p and of q . Let i and j be the smallest subscripts for which d does not divide a_i and does not divide b_j .

In pq , the coefficient of x^{i+j} is

$$c_{i+j} = a_i b_j + \underbrace{(a_{i+1} b_{j-1} + \cdots + a_{i+j} b_0)}_{=:A} + \underbrace{(a_{i-1} b_{j+1} + \cdots + a_0 b_{i+j})}_{=:B}.$$

By the minimality of i and j , d divides both A and B . Since d is the content of pq , d also divides c_{i+j} . But the above implies that d divides $a_i b_j$, which is a contradiction, since d is prime and does not divide a_i nor b_j . \square

Theorem 1.23 (Gauss' Lemma). *If a primitive polynomial $p \in \mathbb{Z}[x]$ can be factorised as $u(x)v(x)$ where $u, v \in \mathbb{Q}[x]$, then it can be factorised as $s(x)t(x)$ where $s, t \in \mathbb{Z}[x]$.*

Proof. If $p(x) = u(x)v(x)$, then by taking out common factors and finding the lowest common denominator, we can write $p = \frac{a}{b} s(x)t(x)$ where a and b are integers and s, t are both primitive. Thus $b p(x) = a s(x)t(x)$. Since p is primitive, the content of bp is b , and similarly the product st is primitive by [lemma 1.22](#), so the content of ast is a . Therefore $a = b$, and $p(x) = s(x)t(x)$, as required. \square

Main Eigenvalues

“All truly great ideas are conceived whilst walking.”

FRIEDRICH NIETZSCHE

The all-ones vector $\mathbf{j} = (1, \dots, 1)$ plays an important role when determining the number of walks of fixed length from a chosen starting vertex, as we have seen in [corollary 1.19](#). In this chapter, the vector \mathbf{j} and its relationship with the eigenspaces of a graph are examined. Many of the ideas presented here are from [\[16\]](#), [\[6\]](#) and [\[14\]](#).

Definitions 2.1 (Main Eigenvalue). Let G be a graph. An eigenvalue μ of G is said to be *main* if the corresponding eigenspace $\mathcal{E}(\mu)$ is not orthogonal to \mathbf{j} , i.e., there exists $x \in \mathcal{E}(\mu)$ such that $\langle x, \mathbf{j} \rangle \neq 0$.

Two graphs having the same main eigenvalues are said to be *comain*. ■

2.1 Main Angles

Suppose that $\mathbf{A}(G)$ has spectral decomposition

$$\mathbf{A} = \mu_1 \mathbf{P}_1 + \mu_2 \mathbf{P}_2 + \dots + \mu_s \mathbf{P}_s$$

where the first p eigenvalues $\mu_1, \mu_2, \dots, \mu_p$ are main, and the remaining eigenvalues μ_{p+1}, \dots, μ_s are non-main. Then *main angles* $\vartheta_1, \dots, \vartheta_s$ of G are

the numbers

$$\vartheta_i = \frac{1}{\sqrt{n}} \|\mathbf{P}_i \mathbf{j}\|$$

i.e., the cosines of the angles between \mathbf{j} and the eigenspaces $\mathcal{E}(\mu_i)$. Evidently, μ_i is main if and only if $\vartheta_i \neq 0$. Moreover, since

$$\begin{aligned} \|\mathbf{j}\|^2 &= \mathbf{j}^\top \mathbf{j} = \mathbf{j}^\top \underbrace{(\mathbf{P}_1^\top \mathbf{P}_1 + \cdots + \mathbf{P}_s^\top \mathbf{P}_s)}_{=\mathbf{I}} \mathbf{j} = (\mathbf{P}_1 \mathbf{j})^\top (\mathbf{P}_1 \mathbf{j}) + \cdots + (\mathbf{P}_s \mathbf{j})^\top (\mathbf{P}_s \mathbf{j}) \\ &= \|\mathbf{P}_1 \mathbf{j}\|^2 + \cdots + \|\mathbf{P}_s \mathbf{j}\|^2, \end{aligned}$$

we have that $\vartheta_1^2 + \cdots + \vartheta_p^2 = 1$.

It is also worth noting that by the Perron–Frobenius theorem, every graph G has a unique largest eigenvalue having a corresponding eigenvector with strictly positive components. In particular, this eigenvector cannot be orthogonal to \mathbf{j} ; so the largest eigenvalue of a graph G is always main.

The main angles of a graph give us a nice formula for the number of walks.

Proposition 2.2. *Let G be a graph on n vertices, let μ_1, \dots, μ_p be its main eigenvalues, and let N_k be the number of walks of length k in G . Then*

$$N_k = n(\vartheta_1^2 \mu_1^k + \cdots + \vartheta_p^2 \mu_p^k).$$

Proof. Suppose \mathbf{A} has spectral decomposition $\mu_1 \mathbf{P}_1 + \cdots + \mu_s \mathbf{P}_s$. Then

$$\begin{aligned} \mathbf{A} \mathbf{j} &= \mu_1 \mathbf{P}_1 \mathbf{j} + \cdots + \mu_p \mathbf{P}_p \mathbf{j} + \underbrace{\mu_{p+1} \mathbf{P}_{p+1} \mathbf{j} + \cdots + \mu_s \mathbf{P}_s \mathbf{j}}_{\text{non-main}} \\ &= \mu_1 \mathbf{P}_1 \mathbf{j} + \cdots + \mu_p \mathbf{P}_p \mathbf{j} \\ \implies \mathbf{A}^k \mathbf{j} &= \mu_1^k \mathbf{P}_1 \mathbf{j} + \cdots + \mu_p^k \mathbf{P}_p \mathbf{j}. \end{aligned}$$

Then by [corollary 1.19](#),

$$N_k = \sum_{i=1}^n [\mathbf{A}^k \mathbf{j}]_i = \mathbf{j}^\top \mathbf{A}^k \mathbf{j} = \sum_{i=1}^p \mu_i^k \mathbf{j}^\top \mathbf{P}_i \mathbf{j} = \sum_{i=1}^p \mu_i^k \|\mathbf{P}_i \mathbf{j}\|^2,$$

and since $\vartheta_i^2 n = \|\mathbf{P}_i \mathbf{j}\|^2$, the result follows. \square

2.2 The Main Polynomial

Recall that the characteristic polynomial $\phi_G(x)$ of a graph is given by

$$\phi_G(x) = \det(x\mathbf{I} - \mathbf{A}) = \prod_{i=1}^s (x - \mu_i)^{m(\mu_i)},$$

where μ_1, \dots, μ_s are the distinct eigenvalues of G having multiplicity $m(\mu_i)$ for $1 \leq i \leq s$. We introduce an analogous function which treats solely main eigenvalues.

Lemma 2.3. *Let G be a graph. Then ϕ_G has integer coefficients.*

Proof. Clearly each entry of $x\mathbf{I} - \mathbf{A}$ is a polynomial with integral coefficients, being either integers or terms of the form $x - a_{ii}$. Since $\det(x\mathbf{I} - \mathbf{A})$ is simply a sum of products of entries (by the Leibniz formula for determinant), it follows that $\det(x\mathbf{I} - \mathbf{A}) \in \mathbb{Z}[x]$. \square

Definition 2.4. Let G be a graph. The *main polynomial* of G , denoted $m_G(x)$, is the polynomial

$$m_G(x) = \prod_{i=1}^s (x - \mu_i),$$

where μ_1, \dots, μ_s are the distinct main eigenvalues of G . \blacksquare

Note that each main eigenvalue μ_i has multiplicity 1 in m_G , regardless of its multiplicity in ϕ_G .

A nice fact about m_G is that its coefficients are always integers. Before we give a proof of this fact, we will need the following theorem due to Cvetković, which provides us with a generating function for the number of walks of length k in a graph G .^[6]

Theorem 2.5 (Cvetković). *Let G be a graph on n vertices with main eigenvalues μ_1, \dots, μ_p , let N_k be the number of walks of length k in G .*

Then we have the following generating function for N_k :

$$\sum_{k=0}^{\infty} N_k t^k = \frac{1}{t} \left((-1)^n \frac{\phi_{\bar{G}}(-\frac{t+1}{t})}{\phi_G(\frac{1}{t})} - 1 \right).$$

Proof. If \mathbf{M} is a non-singular $n \times n$ matrix, and \mathbf{J} is an $n \times n$ matrix consisting entirely of ones, it is straightforward to check that for any x ,

$$\det(\mathbf{M} + x\mathbf{J}) = \det(\mathbf{M}) \left(1 + x \sum_{i=1}^n \sum_{j=1}^n [\mathbf{M}^{-1}]_{ij} \right). \quad (2.1)$$

In particular, we have that $N_k = \sum_{i=1}^n \sum_{j=1}^n [\mathbf{A}^k]_{ij}$ by [theorem 1.18](#), and since for t within a suitable convergence radius,

$$\sum_{k=0}^{\infty} \mathbf{A}^k t^k = (\mathbf{I} - t\mathbf{A})^{-1},$$

we get

$$\sum_{k=0}^{\infty} N_k t^k = \sum_{k=0}^{\infty} \sum_{i=1}^n \sum_{j=1}^n [\mathbf{A}^k]_{ij} t^k = \frac{1}{t} \left(\frac{\det(\mathbf{I} - t\mathbf{A} + t\mathbf{J})}{\det(\mathbf{I} - t\mathbf{A})} - 1 \right)$$

by (2.1) with $\mathbf{M} = \mathbf{I} - t\mathbf{A}$ and $x = t$. But since the adjacency matrix $\bar{\mathbf{A}}$ of \bar{G} is $\mathbf{J} - \mathbf{I} - \mathbf{A}$ ([proposition 0.4](#)), this becomes

$$\begin{aligned} \sum_{k=0}^{\infty} N_k t^k &= \frac{1}{t} \left(\frac{\det((t+1)\mathbf{I} + t\bar{\mathbf{A}})}{\det(\mathbf{I} - t\mathbf{A})} - 1 \right) \\ &= \frac{1}{t} \left((-1)^n \frac{\det(-\frac{t+1}{t}\mathbf{I} - \bar{\mathbf{A}})}{\det(\frac{1}{t}\mathbf{I} - \mathbf{A})} - 1 \right), \end{aligned}$$

as required. □

Now we prove that the main polynomial has integer coefficients. This result is also due to Cvetković.

Proposition 2.6 (Cvetković^[6, 5]). *Let G be a graph. Then $m_G \in \mathbb{Z}[x]$.*

Proof. Consider the function

$$\psi(u) = (-1)^n \frac{\phi_{\bar{G}}(-u-1)}{\phi_G(u)}.$$

By **theorem 2.5** and **proposition 2.2**,

$$\begin{aligned} \psi(u) &= 1 + \frac{1}{u} \sum_{k=0}^{\infty} N_k \left(\frac{1}{u}\right)^k = 1 + \frac{1}{u} \sum_{k=0}^{\infty} n \left(\sum_{i=1}^p \vartheta_i^2 \mu_i^k \right) \left(\frac{1}{u}\right)^k \\ &= 1 + \frac{n}{u} \sum_{i=1}^p \vartheta_i^2 \sum_{k=0}^{\infty} \left(\frac{\mu_i}{u}\right)^k \\ &= 1 + \frac{n}{u} \sum_{i=1}^p \vartheta_i^2 \frac{1}{1 - \frac{\mu_i}{u}} \quad (\text{for } |\frac{1}{u}| < R) \\ &= 1 + n \sum_{i=1}^n \frac{\vartheta_i^2}{u - \mu_i} = \frac{p(u)}{m_G(u)}, \end{aligned}$$

where $p(u)$ is the polynomial obtained by gathering terms on the lowest common denominator $m_G(u)$. Thus $\psi(u)$ has simple poles only at the main eigenvalues of G , so $\phi_{\bar{G}}(-u-1)$ and $\phi_G(u)$ have common factors which cancel. But these common factors must have rational coefficients (by the Euclidean division algorithm), and so must $m_G(u)$. Moreover by **theorem 1.23**, $m_G(u)$ has integer coefficients. \square

Corollary 2.7. *Let G be a graph. A generating function for the number of walks N_k in G is*

$$H_G(t) = \sum_{k=0}^{\infty} N_k t^k = \sum_{i=1}^p \frac{n \vartheta_i^2}{1 - \mu_i t}$$

Proof. In the proof of **proposition 2.6**, simplification of $\psi(u)$ yielded

$$1 + \frac{1}{u} \sum_{k=0}^{\infty} N_k \left(\frac{1}{u}\right)^k = 1 + n \sum_{i=1}^n \frac{\vartheta_i^2}{u - \mu_i}.$$

Put $t = \frac{1}{u}$ and the result follows. \square

2.3 The Main Eigenspace

Let $\{\mathbf{b}_1, \dots, \mathbf{b}_m\}$ be a basis for the m -dimensional eigenspace $\mathcal{E}(\mu)$ of some main eigenvalue μ having multiplicity m in ϕ_G , such that the first one \mathbf{b}_1 is not orthogonal to \mathbf{j} . Now for $2 \leq i \leq m$, define

$$\mathbf{w}_i = \frac{\langle \mathbf{j}, \mathbf{b}_i \rangle}{n} \mathbf{b}_i - \frac{\langle \mathbf{j}, \mathbf{b}_1 \rangle}{n} \mathbf{b}_1.$$

It is easy to check that $\langle \mathbf{w}_i, \mathbf{j} \rangle = 0$ for $i \geq 2$, and that $B'_\mu = \{\mathbf{w}_2, \dots, \mathbf{w}_m, \mathbf{b}_1\}$ is still a basis for $\mathcal{E}(\mu)$. Moreover, Gram-Schmidt orthogonalisation on B'_μ produces an orthonormal basis $B_\mu = \{\mathbf{x}_2, \dots, \mathbf{x}_m, \mathbf{x}_1\}$ for $\mathcal{E}(\mu)$, still having only one vector \mathbf{x}_1 not orthogonal to \mathbf{j} . Denote this vector by \mathbf{x}_μ .

Definition 2.8 (Main Eigenspace). Let G have main eigenvalues μ_1, \dots, μ_p and let $\text{mv}(G) = \{\mathbf{x}_{\mu_1}, \dots, \mathbf{x}_{\mu_p}\}$ denote the uniquely determined set of eigenvectors obtained by the process described above, where each $\mathbf{x}_{\mu_i} \in \mathcal{E}(\mu_i)$ is not orthogonal to \mathbf{j} .

Then the *main eigenspace* of G , denoted $\text{Main}(G)$, is the subspace

$$\text{Main}(G) = \text{span}(\text{mv}(G))$$

of \mathbb{R}^n . ■

The eigenvectors in $\text{mv}(G)$ are orthogonal and linearly independent, as they belong to distinct eigenvalues ([proposition 1.17](#)). Hence $\dim(\text{Main}(G)) = p$. It follows also that $\text{mv}(G)$ can be extended to a basis for \mathbb{R}^n .

Proposition 2.9 (Main Polynomial). *Let G be a graph with adjacency matrix \mathbf{A} . Then*

$$m_{\mathbf{A}}(x) = \phi_{\mathbf{A} \upharpoonright \text{Main}(G)}(x).$$

Proof. Suppose $(\mathbf{A} \upharpoonright \text{Main}(G))\mathbf{x} = \mu\mathbf{x}$. Then $\mathbf{A}\mathbf{x} = \mu\mathbf{x}$, and $\mathbf{x} \in \text{Main}(G)$, i.e., there are α_i such that

$$\mathbf{x} = \alpha_1 \mathbf{x}_{\mu_1} + \dots + \alpha_p \mathbf{x}_{\mu_p}.$$

But x_{μ_i} are all eigenvectors corresponding to distinct eigenvalues (namely μ_i), so their sum cannot be an eigenvector. In other words, all but one of the α_i 's are zero. So x must be a scalar multiple of one of the x_{μ_i} 's. \square

This result immediately gives an analogue to the Cayley-Hamilton theorem.

Corollary 2.10. *Let G be a graph. Then $m_G(\mathbf{A}) \upharpoonright \text{Main}(G) = \mathbf{0}$.*

Proposition 2.11. *Let G be a graph, and let $\text{mv}(G) = \{x_1, \dots, x_p\}$. Then*

$$j = \sqrt{n} \sum_{i=1}^p \gamma_i x_i,$$

where $|\gamma_i| = \vartheta_i$, i.e., the main angles of G .

Proof. Recall, by the process of obtaining $\text{mv}(G)$, that the orthonormal basis B_{μ_i} for $\mathcal{E}(\mu_i)$ contains only one vector x_i with non-zero component along j , i.e., $\langle j, b \rangle = 0$ for all $x_i \neq b \in B_{\mu_i}$. Thus, since $\mathbb{R}^n = \bigoplus_{i=1}^s \mathcal{E}(\mu_i)$,

$$j = \sum_{b \in \bigcup_{i=1}^s B_{\mu_i}} \langle j, b \rangle b = \sum_{i=1}^p \langle j, x_i \rangle x_i. \quad (2.2)$$

Moreover, if we project j onto $\mathcal{E}(\mu_i)$ for some μ_i , the resulting projected vector $\mathbf{P}_i j = \sum_{b \in B_{\mu_i}} \langle j, b \rangle b = \langle j, x_i \rangle x_i$, and since x_i is unit, $\|\mathbf{P}_i j\| = |\langle j, x_i \rangle|$. Thus by (2.2), the result follows. \square

Together with [corollary 2.10](#), this result gives us that $m_G(\mathbf{A})j = \mathbf{0}$.

2.4 The Walk Matrix

In [corollary 1.19](#), the number of walks of length k from vertex i is shown to be the i th entry of the vector $\mathbf{A}^k j$. This motivates the following definition.

Definition 2.12. Let G be a graph with main eigenvalues μ_1, \dots, μ_p . The

k -walk matrix is the $n \times k$ matrix

$$\mathbf{W}_G(k) = \begin{pmatrix} | & | & & | \\ \mathbf{j} & \mathbf{A}\mathbf{j} & \cdots & \mathbf{A}^{k-1}\mathbf{j} \\ | & | & & | \end{pmatrix}.$$

In particular, the walk matrix \mathbf{W}_G of G is the p -walk matrix, i.e., $\mathbf{W}_G = \mathbf{W}_G(p)$, where p is the number of main eigenvalues of G . ■

Theorem 2.13. *The columns $\{\mathbf{j}, \mathbf{A}\mathbf{j}, \dots, \mathbf{A}^{p-1}\mathbf{j}\}$ of \mathbf{W}_G are a basis for $\text{Main}(G)$.*

Proof. Let $\text{mv}(G) = \{x_1, \dots, x_p\}$. Since $\mathbf{j} = \sum_{j=1}^p \beta_j x_j$ by **proposition 2.11** (where $\beta_j = \pm\sqrt{n}\vartheta_j$), we can write $\mathbf{A}^i \mathbf{j} = \sum_{j=1}^p \beta_j \mathbf{A}^i x_j = \sum_{j=1}^p \beta_j \mu_j^i x_j$, so $\text{span}\{\mathbf{j}, \mathbf{A}\mathbf{j}, \dots, \mathbf{A}^{p-1}\mathbf{j}\} \subseteq \text{Main}(G)$.

Now we prove linear independence. Suppose there are α_i such that

$$\sum_{i=0}^{p-1} \alpha_i \mathbf{A}^i \mathbf{j} = \mathbf{0} \implies \sum_{i=0}^{p-1} \alpha_i \sum_{j=1}^p \beta_j \mu_j^i x_j = \mathbf{0} \implies \sum_{j=1}^p \left(\beta_j \sum_{i=0}^{p-1} \alpha_i \mu_j^i \right) x_j = \mathbf{0}.$$

By the linear independence of $\text{mv}(G)$, it follows that $\beta_j \sum_{i=0}^{p-1} \alpha_i \mu_j^i = 0$ for all $1 \leq j \leq p$. Now since $|\beta_j| = \sqrt{n}\vartheta_j \neq 0$ (otherwise μ_j would not be main), we have the equations

$$\begin{pmatrix} 1 & \mu_1 & \mu_1^2 & \cdots & \mu_1^{p-1} \\ 1 & \mu_2 & \mu_2^2 & \cdots & \mu_2^{p-1} \\ \vdots & \vdots & \vdots & \ddots & \vdots \\ 1 & \mu_p & \mu_p^2 & \cdots & \mu_p^{p-1} \end{pmatrix} \begin{pmatrix} \alpha_0 \\ \alpha_1 \\ \vdots \\ \alpha_{p-1} \end{pmatrix} = \mathbf{0}.$$

The left hand-side is the well-known Vandermonde matrix, whose determinant is non-zero for distinct μ_i . Thus the only solution to this system is $\alpha_0 = \cdots = \alpha_{p-1} = 0$, as required.

Thus $\{\mathbf{j}, \mathbf{A}\mathbf{j}, \dots, \mathbf{A}^{p-1}\mathbf{j}\}$ is a set of $p = \dim(\text{Main}(G))$ linearly independent vectors in $\text{Main}(G)$, so they form a basis. □

An immediate consequence is the following fact about walk matrices.

Corollary 2.14. *Let G be a graph, and let $\mathbf{W}_G(k)$ be its k -walk matrix. Then*

$$\text{rank}(\mathbf{W}_G(k)) = \min\{k, p\}.$$

Moreover, if we have the walk matrix \mathbf{W}_G of a graph G , we can obtain $\mathbf{W}_G(k)$ for $k \geq p$ using $m_{\mathbf{A}}(G)$.

Proposition 2.15. *Let G be a graph, and suppose its main polynomial is $m_G(x) = x^p - c_0x^{p-1} - \dots - c_{p-2}x - c_{p-1}$. Then*

$$\mathbf{A}^p \mathbf{j} = c_0 \mathbf{j} + c_1 \mathbf{A} \mathbf{j} + \dots + c_{p-1} \mathbf{A}^{p-1} \mathbf{j}.$$

Multiplying by \mathbf{A}^{i-p} for $i \geq p$, one obtains a recurrence relation for the i th column of $\mathbf{W}_G(k)$ in terms of the previous p columns.

Proof. By the analogue of the Cayley-Hamilton theorem ([corollary 2.10](#)), we have $m_G(\mathbf{A})\mathbf{j} = \mathbf{0}$, which gives the result. \square

Corollary 2.16. *Any two comain graphs with the same walk matrix have the same k -walk matrix for any $k \geq p$.*

Proof. Any two comain graphs have the same main polynomial, so [proposition 2.15](#) gives the result. \square

Counterexample 2.17. Unfortunately this is untrue for graphs which are not comain. The two pairs (G_{5622}, G_{12058}) and (G_{5626}, G_{12093}) are counterexamples obtained using Mathematica. They are the only counterexamples on ≤ 8 vertices having the same walk matrix, but not the same k -walk matrix for $k \geq p$.

Refer to [figure 2.1](#). The numbering of the graphs is in accordance with the list of non-isomorphic graphs on 8 vertices provided on Brendan McKay's graph data website.^[13] \blacksquare

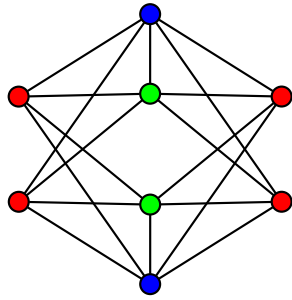

G_{5622}

Main Eigenvalues: $\frac{1-\sqrt{65}}{2}, \frac{1+\sqrt{65}}{2}$

Walk Matrix	3-walk Matrix
$\begin{pmatrix} 1 & 4 \\ 1 & 4 \\ 1 & 4 \\ 1 & 4 \\ 1 & 5 \\ 1 & 5 \\ 1 & 5 \\ 1 & 5 \end{pmatrix}$	$\begin{pmatrix} 1 & 4 & 20 \\ 1 & 4 & 20 \\ 1 & 4 & 20 \\ 1 & 4 & 20 \\ 1 & 5 & 21 \\ 1 & 5 & 21 \\ 1 & 5 & 21 \\ 1 & 5 & 21 \end{pmatrix}$

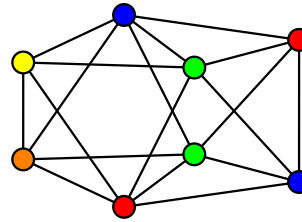

G_{12058}

Main Eigenvalues: $\frac{3-\sqrt{37}}{2}, \frac{3+\sqrt{37}}{2}$

Walk Matrix	3-walk Matrix
$\begin{pmatrix} 1 & 4 \\ 1 & 4 \\ 1 & 4 \\ 1 & 4 \\ 1 & 5 \\ 1 & 5 \\ 1 & 5 \\ 1 & 5 \end{pmatrix}$	$\begin{pmatrix} 1 & 4 & 19 \\ 1 & 4 & 19 \\ 1 & 4 & 19 \\ 1 & 4 & 19 \\ 1 & 5 & 22 \\ 1 & 5 & 22 \\ 1 & 5 & 22 \\ 1 & 5 & 22 \end{pmatrix}$

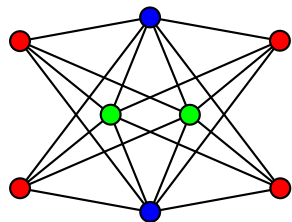

G_{5626}

Main Eigenvalues: $1 + \sqrt{17}, 1 - \sqrt{17}$

Walk Matrix	3-walk Matrix
$\begin{pmatrix} 1 & 4 \\ 1 & 4 \\ 1 & 4 \\ 1 & 4 \\ 1 & 6 \\ 1 & 6 \\ 1 & 6 \\ 1 & 6 \end{pmatrix}$	$\begin{pmatrix} 1 & 4 & 24 \\ 1 & 4 & 24 \\ 1 & 4 & 24 \\ 1 & 4 & 24 \\ 1 & 6 & 28 \\ 1 & 6 & 28 \\ 1 & 6 & 28 \\ 1 & 6 & 28 \end{pmatrix}$

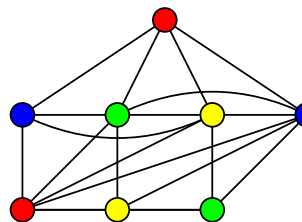

G_{12093}

Main Eigenvalues: $2 + \sqrt{10}, 2 - \sqrt{10}$

Walk Matrix	3-walk Matrix
$\begin{pmatrix} 1 & 4 \\ 1 & 4 \\ 1 & 4 \\ 1 & 4 \\ 1 & 6 \\ 1 & 6 \\ 1 & 6 \\ 1 & 6 \end{pmatrix}$	$\begin{pmatrix} 1 & 4 & 22 \\ 1 & 4 & 22 \\ 1 & 4 & 22 \\ 1 & 4 & 22 \\ 1 & 6 & 30 \\ 1 & 6 & 30 \\ 1 & 6 & 30 \\ 1 & 6 & 30 \end{pmatrix}$

FIGURE 2.1: The only two counterexamples on ≤ 8 vertices, as described in counterexample 2.17.

CHAPTER 3

Canonical Double Covers

“You keep using that word, I do not think it means what you think it means.”

INIGO MONTOYA
(THE PRINCESS BRIDE)

Most of the results presented here, as well as their proofs, are from [4].

The *canonical double covering* (or bipartite cover) of a graph $G = (\mathcal{V}, \mathcal{E})$ of order n , denoted by $\text{CDC}(G)$, is a graph $G' = (\mathcal{V}', \mathcal{E}')$ of order $2n$ where $\mathcal{V}' = \mathcal{V} \times \{0, 1\}$, and $\mathcal{E}' = \{ \{(u, 0), (v, 1)\}, \{(u, 1), (v, 0)\} : \{u, v\} \in \mathcal{E} \}$. In other words, $\text{CDC}(G)$ is obtained by producing two copies of the vertex set, and replacing edges $\{u, v\}$ in the original graph by edges from the first copy to the second copy, and vice-versa (see [figure 3.1](#) for examples). Clearly, $\text{CDC}(G)$ is always bipartite, with partite sets $\mathcal{V} \times \{0\}$ and $\mathcal{V} \times \{1\}$.

If the vertices in $\mathcal{V} \times \{0\}$ are given the first n labels, then it is not hard to see that the adjacency matrix of $\text{CDC}(G)$ is given by

$$\mathbf{A}(\text{CDC}(G)) = \left(\begin{array}{c|c} \mathbf{O} & \mathbf{A}(G) \\ \hline \mathbf{A}(G) & \mathbf{O} \end{array} \right).$$

This is actually equivalent to the so-called direct product of G with K_2 , i.e., $\text{CDC}(G) = G \times K_2$. The direct product was introduced by Whitehead and Russell in *Principia Mathematica*, as an operation on binary relations.^[15]

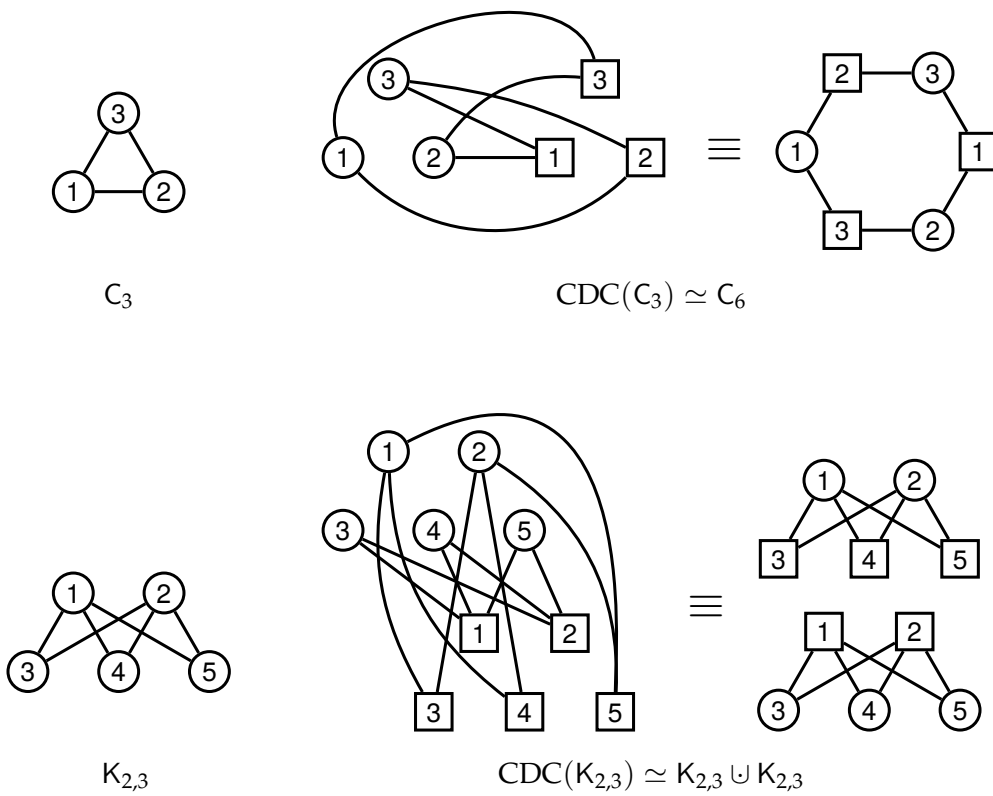

FIGURE 3.1: Canonical double coverings of C_3 and $K_{2,3}$, where vertices $(v, 0)$ are represented by circle nodes, and vertices $(v, 1)$ by square nodes.

3.1 Two Structural Results

The following first result utilises CDC's to distinguish between bipartite and non-bipartite connected graphs.

Proposition 3.1. *Let G be a connected graph. Then G is bipartite if and only if $\text{CDC}(G)$ is disconnected. Moreover, if G is bipartite, then $\text{CDC}(G) \simeq G \cup G$.*

Proof. Let G be bipartite, and let $\mathcal{U}_1, \mathcal{U}_2$ be the partite sets of G . Consider $\text{CDC}(G)$, and let $\mathcal{V}_i = \{(v, 0) : v \in \mathcal{U}_i\}$ and $\mathcal{V}'_i = \{(v, 1) : v \in \mathcal{U}_i\}$ for $i = 1, 2$ be the corresponding partite sets and their copies in $\text{CDC}(G)$. Since edges in G are only from \mathcal{U}_1 to \mathcal{U}_2 , then edges in $\text{CDC}(G)$ are only either from \mathcal{V}_1 to \mathcal{V}'_2 or \mathcal{V}_2 to \mathcal{V}'_1 . Therefore $\text{CDC}(G)$ is disconnected with components being precisely the induced subgraphs on $\mathcal{V}_1 \cup \mathcal{V}'_2$ and $\mathcal{V}_2 \cup \mathcal{V}'_1$, both of which are isomorphic to G .

For the converse, suppose $\text{CDC}(G)$ is connected. Identify $v_1 \equiv (v_1, 0)$ and $v'_1 \equiv (v_1, 1)$ as notations for the two copies in $\text{CDC}(G)$ of a vertex v_1 in G . Since $\text{CDC}(G)$ is connected, there is a path $(v_1, v'_2, v_3, \dots, v'_{k-1}, v_k, v'_1)$ joining v_1 to v'_1 , where the vertices alternate from one copy of the vertex set to another. But this corresponds to the odd cycle $(v_1, v_2, v_3, \dots, v_k, v_1)$ in G . Hence by [proposition 0.3](#), G is not bipartite. \square

Next we prove that the CDC operation is additive with respect to disjoint union.

Proposition 3.2. *Let G be disconnected with components G_1, \dots, G_k , so that $G = G_1 \cup \dots \cup G_k$ and G_i is connected for $1 \leq i \leq k$. Then*

$$\text{CDC}(G) = \text{CDC}\left(\bigcup_{i=1}^k G_i\right) \simeq \bigcup_{i=1}^k \text{CDC}(G_i).$$

Proof. We give the proof for $k = 2$, the general case follows by induction. If G has components G_1 and G_2 , then labelling the vertices of G_1 first gives us

that the adjacency matrix of G has block form

$$\mathbf{A}(G) = \left(\begin{array}{c|c} \mathbf{A}(G_1) & \mathbf{O} \\ \hline \mathbf{O} & \mathbf{A}(G_2) \end{array} \right),$$

and so

$$\mathbf{A}(\text{CDC}(G)) = \left(\begin{array}{cc|cc} & & \mathbf{A}(G_1) & \mathbf{O} \\ & \mathbf{O} & \mathbf{O} & \mathbf{A}(G_2) \\ \hline \mathbf{A}(G_1) & \mathbf{O} & & \\ \hline \mathbf{O} & \mathbf{A}(G_2) & & \mathbf{O} \end{array} \right). \quad (3.1)$$

On the other hand, for $i = 1, 2$, we have

$$\mathbf{A}(\text{CDC}(G_i)) = \left(\begin{array}{c|c} \mathbf{O} & \mathbf{A}(G_i) \\ \hline \mathbf{A}(G_i) & \mathbf{O} \end{array} \right),$$

so that

$$\mathbf{A}(\text{CDC}(G_1) \cup \text{CDC}(G_2)) = \left(\begin{array}{cc|cc} & & \mathbf{A}(G_1) & & & \\ & & \mathbf{A}(G_1) & \mathbf{O} & & \mathbf{O} \\ \hline & & & & \mathbf{O} & \mathbf{A}(G_2) \\ & \mathbf{O} & & & \mathbf{A}(G_2) & \mathbf{O} \end{array} \right). \quad (3.2)$$

When considering [equations \(3.1\)](#) and [\(3.2\)](#), it is not hard to see that the permutation matrix

$$\mathbf{P} = \left(\begin{array}{c|c|c|c} \mathbf{I}_1 & \mathbf{O} & \mathbf{O} & \mathbf{O} \\ \hline \mathbf{O} & \mathbf{O} & \mathbf{I}_2 & \mathbf{O} \\ \hline \mathbf{O} & \mathbf{I}_1 & \mathbf{O} & \mathbf{O} \\ \hline \mathbf{O} & \mathbf{O} & \mathbf{O} & \mathbf{I}_2 \end{array} \right),$$

where \mathbf{I}_i denotes the $|\mathcal{V}(G_i)| \times |\mathcal{V}(G_i)|$ identity matrix, gives the required relabelling:

$$\mathbf{P}^\top \mathbf{A}(\text{CDC}(G)) \mathbf{P} = \mathbf{A}(\text{CDC}(G_1) \cup \text{CDC}(G_2)),$$

so that $\text{CDC}(G) \simeq \text{CDC}(G_1) \cup \text{CDC}(G_2)$, as required. \square

3.2 Graphs with the same CDC

If two graphs G, H have isomorphic canonical double coverings, that is, $\text{CDC}(G) \simeq \text{CDC}(H)$, this does not determine H . Moreover, it does not even determine connectivity, i.e., if G is connected, we do not necessarily have that H is connected. Indeed, since C_6 is bipartite, we have $\text{CDC}(C_6) = C_6 \cup C_6$ by [proposition 3.1](#). But then by [proposition 3.2](#) and [figure 3.1](#), we have $\text{CDC}(K_3 \cup K_3) = \text{CDC}(K_3) \cup \text{CDC}(K_3) = C_6 \cup C_6$. Thus we have two graphs with the same CDC, where one is connected, and the other is disconnected.

However, we do have the following.

Lemma 3.3. *Let G and H be two graphs with $\text{CDC}(G) \simeq \text{CDC}(H)$. Then G has no isolated vertices if and only if H has no isolated vertices.*

Proof. Indeed, if G has an isolated vertex, then $G = G' \cup K_1$, so

$$\text{CDC}(G) = \text{CDC}(G' \cup K_1) = \text{CDC}(G') \cup \text{CDC}(K_1) = \text{CDC}(G') \cup \bar{K}_2$$

by [proposition 3.2](#), and therefore $\text{CDC}(H) = \text{CDC}(G') \cup \bar{K}_2$. Thus the matrix

$$\mathbf{A}(\text{CDC}(H)) = \left(\begin{array}{c|c} \mathbf{O} & \mathbf{A}(H) \\ \hline \mathbf{A}(H) & \mathbf{O} \end{array} \right),$$

has two whole columns of zeros, corresponding to the isolated vertices which make up \bar{K}_2 . But a column of zeros in the matrix above arises only when a whole column of zeros is present in one of the non-zero blocks $\mathbf{A}(H)$, and since both non-zero blocks are equal, then these two columns must be dis-

tributed equally among both $\mathbf{A}(H)$'s (otherwise they would be different). In other words, $\mathbf{A}(H)$ must have a column of zeros, and consequently H has an isolated vertex. This argument is symmetric by interchanging G and H , so we also have the converse. \square

This proposition is the key which allows us to prove the following theorem, which is one of the main results of this chapter.

Theorem 3.4. *Suppose G and H are two graphs with adjacency matrices \mathbf{A}_G and \mathbf{A}_H . Then $\text{CDC}(G) \simeq \text{CDC}(H)$ if and only if there exist two permutation matrices \mathbf{Q} and \mathbf{R} such that*

$$\mathbf{Q} \mathbf{A}_G \mathbf{R} = \mathbf{A}_H.$$

Proof. Suppose, without loss of generality, that the graphs G and H have no isolated vertices (if they do, then by [lemma 3.3](#), we could simply pair them off until we are left with two graphs having no isolated vertices). If $\text{CDC}(G) \simeq \text{CDC}(H)$, then there exists a permutation matrix \mathbf{P} such that

$$\begin{aligned} \mathbf{P}^\top \left(\begin{array}{c|c} \mathbf{O} & \mathbf{A}_G \\ \mathbf{A}_G & \mathbf{O} \end{array} \right) \mathbf{P} &= \left(\begin{array}{c|c} \mathbf{O} & \mathbf{A}_H \\ \mathbf{A}_H & \mathbf{O} \end{array} \right) \\ \implies \left(\begin{array}{c|c} \mathbf{P}_{11}^\top & \mathbf{P}_{21}^\top \\ \mathbf{P}_{12}^\top & \mathbf{P}_{22}^\top \end{array} \right) \left(\begin{array}{c|c} \mathbf{O} & \mathbf{A}_G \\ \mathbf{A}_G & \mathbf{O} \end{array} \right) \left(\begin{array}{c|c} \mathbf{P}_{11} & \mathbf{P}_{12} \\ \mathbf{P}_{21} & \mathbf{P}_{22} \end{array} \right) &= \left(\begin{array}{c|c} \mathbf{O} & \mathbf{A}_H \\ \mathbf{A}_H & \mathbf{O} \end{array} \right). \end{aligned}$$

Multiplying out and comparing entries, we get that

$$\mathbf{P}_{21}^\top \mathbf{A}_G \mathbf{P}_{12} + \mathbf{P}_{11}^\top \mathbf{A}_G \mathbf{P}_{22} = \mathbf{A}_H \quad (3.3)$$

$$\mathbf{P}_{21}^\top \mathbf{A}_G \mathbf{P}_{11} = \mathbf{P}_{12}^\top \mathbf{A}_G \mathbf{P}_{22} = \mathbf{O}, \quad (3.4)$$

where [equation \(3.4\)](#) follows since all matrices have non-negative entries.

Now observe that

$$(\mathbf{P}_{11} + \mathbf{P}_{21})^\top \mathbf{A}_G (\mathbf{P}_{22} + \mathbf{P}_{12}) = \mathbf{A}_H$$

by [equations \(3.3\)](#) and [\(3.4\)](#). We claim that $\mathbf{Q} := (\mathbf{P}_{11} + \mathbf{P}_{21})^\top$ and $\mathbf{R} :=$

$\mathbf{P}_{22} + \mathbf{P}_{12}$ are permutation matrices. Suppose not. Being the sum of two submatrices of \mathbf{P} , this can only happen if a row (and column) are zero. But then \mathbf{A}_H will have a row of zeros, corresponding to an isolated vertex in H , a contradiction.

Conversely, if $\mathbf{Q}\mathbf{A}_G\mathbf{R} = \mathbf{A}_H$, then clearly

$$\mathbf{P} := \left(\begin{array}{c|c} \mathbf{O} & \mathbf{Q} \\ \mathbf{R}^\top & \mathbf{O} \end{array} \right)$$

defines a permutation matrix, and it is easy to verify that

$$\mathbf{P}^\top \left(\begin{array}{c|c} \mathbf{O} & \mathbf{A}_G \\ \mathbf{A}_G & \mathbf{O} \end{array} \right) \mathbf{P} = \left(\begin{array}{c|c} \mathbf{O} & \mathbf{A}_H \\ \mathbf{A}_H & \mathbf{O} \end{array} \right),$$

as required. □

This weakened notion of graph isomorphism, where $\mathbf{Q}\mathbf{A}_G\mathbf{R} = \mathbf{A}_H$ and the permutation matrices \mathbf{Q} and \mathbf{R} are not necessarily inverses, was first studied by Lauri et al. in [11]. They give a different proof of [theorem 3.4](#) which uses a combinatorial argument. Such graphs are said to be *two-fold isomorphic* or *TF-isomorphic*, and we write

$$G \stackrel{\text{TF}}{\cong} H.$$

The pair of permutations (\mathbf{Q}, \mathbf{R}) is called the *TF-isomorphism*.

In [11], the authors discuss a pair of TF-isomorphic graphs on 7 vertices found by B. Zelinka. In [appendix A](#), we present an exhaustive list of 32 non-isomorphic graph pairs which have the same CDC on up to 8 vertices. The Zelinka example corresponds to the pair (G_{1164}, H_{1032}) .

3.3 Establishing a Hierarchy

In this final section, we compare the strength of relationships and similarities between graphs using the results of this chapter and the previous one to establish a hierarchy in view of their main eigenvalues, main eigenspaces,

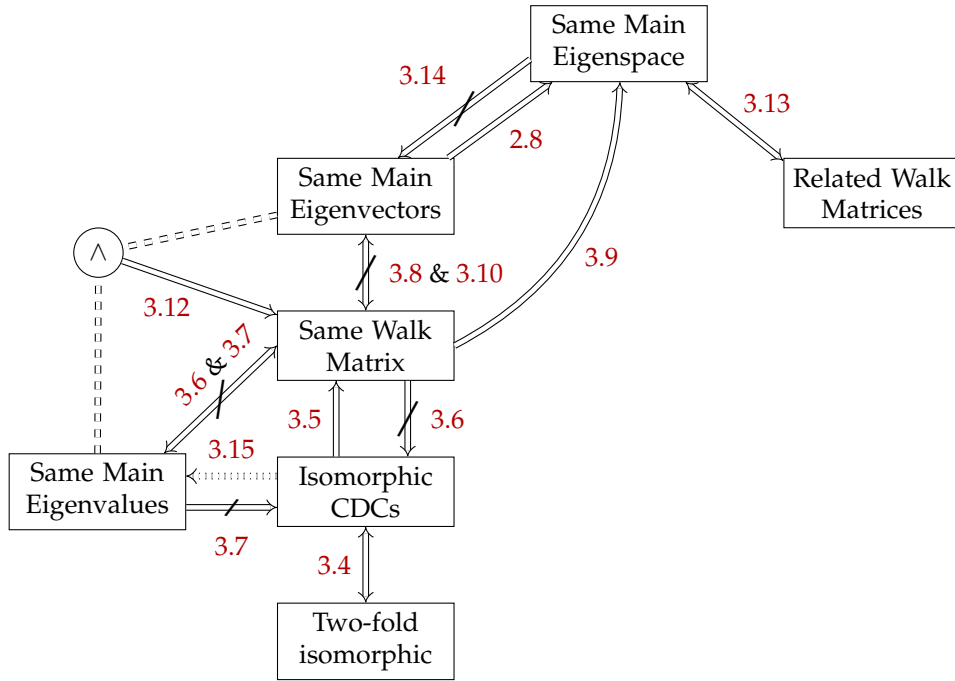

FIGURE 3.2: The hierarchy we present through our results. The arrow \Rightarrow means “implies”, and \nRightarrow means “does not imply”. The combination \Leftrightarrow is short for \Rightarrow and \Leftarrow , i.e., “implies and is implied by”, and similarly \nLeftrightarrow is short for \nRightarrow and \nLeftarrow , i.e., “does not imply and is not implied by”. The dashed lines which merge at the \wedge node denote the conjunction of those two results. The dotted lines denote a conjecture.

main eigenvalues, walk matrices, and CDCs.

That being TF-isomorphic and having isomorphic CDC’s are equivalent is established by **theorem 3.4**. Next, we show that having isomorphic CDC’s implies having the same k -walk matrix for any k , and in particular, the same walk matrix.

Theorem 3.5. *Let G, H be two graphs with $CDC(G) \simeq CDC(H)$, and let k be a natural number. Then*

$$W_G(k) = W_H(k)$$

for appropriate labelling of the vertices.

Proof. For a graph Γ , let $A_\Gamma = A(\Gamma)$ and $C_\Gamma = A(CDC(\Gamma))$. Since $CDC(G) \simeq$

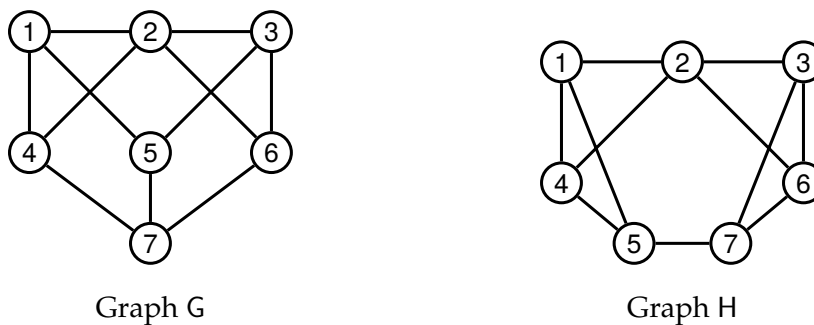

FIGURE 3.3: Graphs G and H give a counterexample to the converse of **theorem 3.5**, since they have the same walk matrix but different CDC's.

$\text{CDC}(H)$, we can relabel the vertices of the graph H to get H' , so that $\mathbf{C}_G = \mathbf{C}_{H'}$. Now for any $0 \leq \ell \leq k$, we have that

$$\mathbf{C}_G^\ell \mathbf{j} = \begin{pmatrix} \mathbf{A}_G^\ell \mathbf{j} \\ \mathbf{A}_G^\ell \mathbf{j} \end{pmatrix} \quad \text{and} \quad \mathbf{C}_{H'}^\ell \mathbf{j} = \begin{pmatrix} \mathbf{A}_{H'}^\ell \mathbf{j} \\ \mathbf{A}_{H'}^\ell \mathbf{j} \end{pmatrix},$$

but since $\mathbf{C}_G = \mathbf{C}_{H'}$, it follows that $\mathbf{A}_G^\ell \mathbf{j} = \mathbf{A}_{H'}^\ell \mathbf{j}$ for all $0 \leq \ell \leq k$, so the columns of $\mathbf{W}_G(k)$ and $\mathbf{W}_H(k)$ are equal. \square

Now we show that the converse is false.

Counterexample 3.6. A counterexample of the converse of **theorem 3.5** is given in **figure 3.3**. Indeed, those graphs have

$$\mathbf{W}_G = \begin{pmatrix} 1 & 3 & 9 \\ 1 & 3 & 10 \\ 1 & 3 & 10 \\ 1 & 3 & 10 \\ 1 & 3 & 10 \\ 1 & 3 & 9 \\ 1 & 4 & 12 \end{pmatrix} = \mathbf{W}_H,$$

but $\text{CDC}(G) \neq \text{CDC}(H)$.

Moreover, these two graphs have distinct main eigenvalues, which shows that same walk matrix $\not\Rightarrow$ same main eigenvalues. \blacksquare

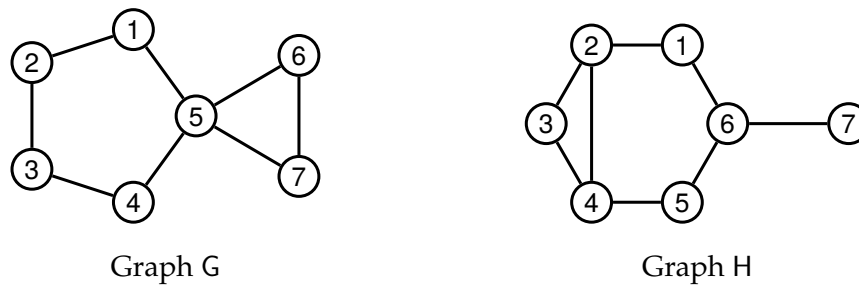

FIGURE 3.4: Graphs G and H have the same main eigenvalues, but have different walk matrices.

Counterexample 3.7. The graphs G and H of [figure 3.4](#) prove that the converse is also false, i.e., that having the same main eigenvalues does not imply that the graphs have the same walk matrix.

Indeed, they both have main polynomial $x(x^3 - 2x^2 - 4x + 7)$, but their walk matrices are

$$\mathbf{W}_G = \begin{pmatrix} 1 & 2 & 6 & 12 \\ 1 & 2 & 4 & 10 \\ 1 & 2 & 4 & 10 \\ 1 & 2 & 6 & 12 \\ 1 & 4 & 8 & 24 \\ 1 & 2 & 6 & 14 \\ 1 & 2 & 6 & 14 \end{pmatrix}, \quad \mathbf{W}_H = \begin{pmatrix} 1 & 2 & 6 & 12 \\ 1 & 3 & 7 & 19 \\ 1 & 2 & 6 & 14 \\ 1 & 3 & 7 & 19 \\ 1 & 2 & 6 & 12 \\ 1 & 3 & 5 & 15 \\ 1 & 1 & 3 & 5 \end{pmatrix}.$$

It is also easy to check that their CDC's are not isomorphic. ■

Counterexample 3.8. Here we show that graphs having the same walk matrix do not necessarily have the same main eigenvectors. Indeed, the two pairs of graphs in [counterexample 2.17](#) have the same walk matrix but different eigenvectors.

The span of their eigenvectors however, results in the same space. ■

In fact:

Proposition 3.9. *Let G and H be two graphs with the same walk matrix. Then $\text{Main}(G) = \text{Main}(H)$.*

Proof. This follows immediately by [theorem 2.13](#). □

Thus the leap from eigenvectors to eigenspace makes a difference. In fact, it turns out that if two graphs have the same main eigenvectors but different main eigenvalues, they can never have the same walk matrix:

Proposition 3.10. *Let G and H be two graphs with the same main eigenvectors but different main eigenvalues. Then $\mathbf{W}_G(k) \neq \mathbf{W}_H(k)$ for all $k \geq 2$.*

Proof. Let G and H both have the same main eigenvectors $\text{mv}(G) = \text{mv}(H) = \{x_1, \dots, x_p\}$, but different eigenvalues, $\mu_1^G, \dots, \mu_p^G, \mu_1^H, \dots, \mu_p^H$. By [proposition 2.11](#), the first non- j column of $\mathbf{W}_G(k)$ is

$$\mathbf{A}_G \mathbf{j} = \sqrt{n} \sum_{i=1}^p \gamma_i \mathbf{A}_G x_i = \sqrt{n} \sum_{i=1}^p \gamma_i \mu_i^G x_i \neq \sqrt{n} \sum_{i=1}^p \gamma_i \mu_i^H x_i = \mathbf{A}_H \mathbf{j},$$

since the x_i are linearly independent, as required. \square

Example 3.11. [Proposition 3.10](#) establishes a non-implication. However, even though it is proven in general, we must ensure that it is not vacuously true.

The graphs G and H in [figure 3.5](#) both have main eigenvectors

$$\left(\frac{1}{2}(-1 \pm \sqrt{5}), \frac{1}{2}(-1 \pm \sqrt{5}), \frac{1}{2}(-1 \pm \sqrt{5}), \frac{1}{2}(-1 \pm \sqrt{5}), 1, 1, 1, 1\right),$$

but their walk matrices are

$$\mathbf{W}_G = \begin{pmatrix} 1 & 2 \\ 1 & 2 \\ 1 & 2 \\ 1 & 2 \\ 1 & 4 \\ 1 & 4 \\ 1 & 4 \\ 1 & 4 \end{pmatrix} \quad \text{and} \quad \mathbf{W}_H = \begin{pmatrix} 1 & 3 \\ 1 & 3 \\ 1 & 3 \\ 1 & 3 \\ 1 & 6 \\ 1 & 6 \\ 1 & 6 \\ 1 & 6 \end{pmatrix}.$$

Indeed, their main eigenvalues are different. G has main eigenvalues $1 \pm \sqrt{5}$, whereas H has main eigenvalues $\frac{3}{2}(1 \pm \sqrt{5})$. \blacksquare

On the other hand, the same main eigenvalues and eigenvectors yield a unique k -walk matrix for any k :

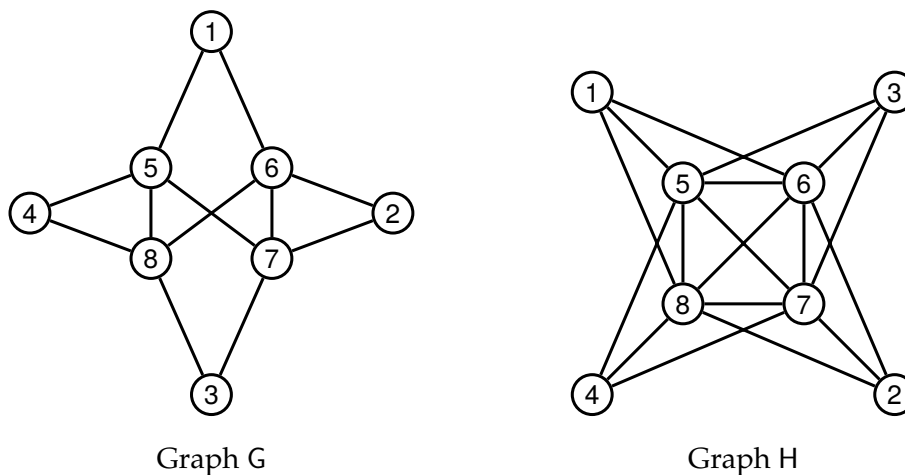

FIGURE 3.5: Graphs G and H have the same main eigenvectors, but have different walk matrices.

Theorem 3.12. *Let $k \in \mathbb{N}$, and suppose G and H are two comain graphs with the same main eigenvectors. Then*

$$\mathbf{W}_G(k) = \mathbf{W}_H(k).$$

Proof. Suppose G and H have main eigenvalues μ_1, \dots, μ_p , and corresponding main eigenvectors $\mathbf{x}_1, \dots, \mathbf{x}_p$. By [proposition 2.11](#) we may express \mathbf{j} as $\mathbf{j} = \sum_{i=1}^p \beta_i \mathbf{x}_i$. Now the ℓ th column of $\mathbf{W}_G(k)$ is the vector $\mathbf{A}_G^{\ell-1} \mathbf{j}$, so

$$\begin{aligned} \mathbf{A}_G^{\ell-1} \mathbf{j} &= \mathbf{A}_G^{\ell-1} \sum_{i=1}^p \beta_i \mathbf{x}_i = \sum_{i=1}^p \beta_i \mathbf{A}_G^{\ell-1} \mathbf{x}_i \\ &= \sum_{i=1}^p \beta_i \mu_i^{\ell-1} \mathbf{x}_i = \sum_{i=1}^p \beta_i \mathbf{A}_H^{\ell-1} \mathbf{x}_i \\ &= \mathbf{A}_H^{\ell-1} \sum_{i=1}^p \beta_i \mathbf{x}_i = \mathbf{A}_H^{\ell-1} \mathbf{j}, \end{aligned}$$

i.e., the ℓ th column of $\mathbf{W}_H(k)$. □

Finally we elaborate on what is meant by “related walk matrices” in [figure 3.2](#).

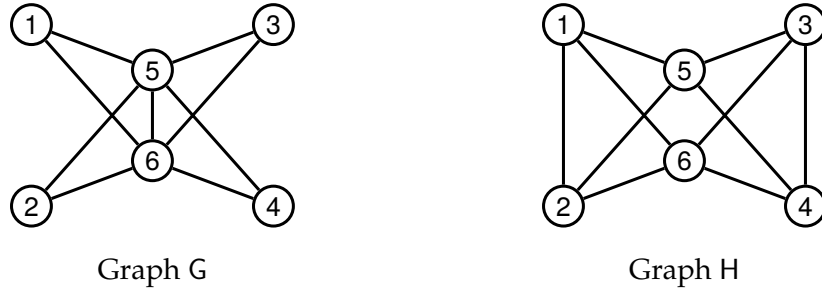

FIGURE 3.6: Graphs G and H have related walk matrices.

Proposition 3.13. *Let G and H be two graphs. Then $\text{Main}(G) = \text{Main}(H)$ if and only if there is an invertible matrix \mathbf{Q} such that $\mathbf{W}_G \mathbf{Q} = \mathbf{W}_H$.*

Proof. If $\text{Main}(G) = \text{Main}(H)$, then the columns of \mathbf{W}_G and \mathbf{W}_H are both bases for the same space by [theorem 2.13](#). In particular, the columns of \mathbf{W}_H can be expressed as a linear combination of those of \mathbf{W}_G . Indeed, if the i th column c_i is $\alpha_{i1} \mathbf{j} + \alpha_{i2} \mathbf{A}_G \mathbf{j} + \dots + \alpha_{ip} \mathbf{A}_G^{p-1} \mathbf{j}$, then

$$\mathbf{W}_H = \begin{pmatrix} | & | & \cdots & | \\ c_1 & c_2 & \cdots & c_p \\ | & | & \cdots & | \end{pmatrix} = \begin{pmatrix} | & | & \cdots & | \\ \mathbf{j} & \mathbf{A}_G \mathbf{j} & \cdots & \mathbf{A}_G^{p-1} \mathbf{j} \\ | & | & \cdots & | \end{pmatrix} \underbrace{\begin{pmatrix} \alpha_{11} & \cdots & \alpha_{1p} \\ \vdots & \ddots & \vdots \\ \alpha_{p1} & \cdots & \alpha_{pp} \end{pmatrix}}_{=\mathbf{Q}}.$$

\mathbf{Q} must be invertible, since otherwise $\text{rank}(\mathbf{W}_H) \neq p$.

Now for the converse, in $\mathbf{W}_H = \mathbf{W}_G \mathbf{Q}$ the columns of \mathbf{W}_G are combined linearly by \mathbf{Q} so they are still members of $\text{Main}(G)$. Since \mathbf{Q} is invertible, none of the columns of \mathbf{W}_G become linearly dependent, so they still span all of $\text{Main}(G)$. Thus $\text{Main}(H) = \text{Main}(G)$. □

Example 3.14. An example of graphs having related walk matrices is given in [figure 3.6](#). These correspond to graphs 31 and 37 from [\[5\]](#), and were pointed out by Jeremy Curmi.

Indeed, we have

$$\mathbf{W}_G = \begin{pmatrix} 1 & 2 \\ 1 & 2 \\ 1 & 2 \\ 1 & 2 \\ 1 & 5 \\ 1 & 5 \end{pmatrix} = \begin{pmatrix} 1 & 3 \\ 1 & 3 \\ 1 & 3 \\ 1 & 3 \\ 1 & 4 \\ 1 & 4 \end{pmatrix} \begin{pmatrix} 1 & -7 \\ 0 & 3 \end{pmatrix} = \mathbf{W}_H \begin{pmatrix} 1 & -7 \\ 0 & 3 \end{pmatrix} = \mathbf{W}_H \mathbf{Q}.$$

This same pair of graphs also serves as a counterexample to the following: having the same main eigenspace does not necessarily mean they have the same main eigenvectors. Indeed, the linearly independent main eigenvectors of G are $(1, 1, 1, 1, \frac{1}{4}(1 \pm \sqrt{33}), \frac{1}{4}(1 \pm \sqrt{33}))$, whereas those of H are $(1, 1, 1, 1, \frac{1}{4}(-1 \pm \sqrt{33}), \frac{1}{4}(-1 \pm \sqrt{33}))$. ■

We end with a conjecture which if true, would link CDC's more intimately to their main eigenvalues.

Conjecture 3.15. *Let G and H be two graphs with $\text{CDC}(G) \simeq \text{CDC}(H)$. Then G and H have the same main eigenvalues.*

Remark 3.16. Even though in [appendix A](#) we narrow the search space to consider only graphs which are comain, the list is still exhaustive, because it was determined by an algorithm that there are no counterexamples to [conjecture 3.15](#) on ≤ 8 vertices. ■

APPENDIX A

All Pairs of TF-Isomorphic Graphs on 8 Vertices

“What’s the use of a book without pictures?”

LEWIS CARROLL
(Alice in Wonderland)

In this appendix, we give a complete list of all the TF-isomorphic graphs on 8 vertices, that is, all pairs of graphs G, H with $\text{CDC}(G) \simeq \text{CDC}(H)$ and $G \not\cong H$.

Since for any pair of TF-isomorphic graphs, we have

$$\text{CDC}(G \cup K_1) \simeq \text{CDC}(H \cup K_1)$$

by [lemma 3.3](#), it is clear that this list contains all possible TF-isomorphic graphs on $n \leq 8$ vertices (those pairs with $n < 8$ will correspond to graphs with isolated vertices added to both, such as the first pair in the table).

A.1 The List

This list was constructed by running a simple C program which made use of the list of non-isomorphic graphs on 8 vertices available on Brendan McKay’s website.^[13] First, the large search space of $\binom{12346}{2} = 76\,205\,685$ pairs of non-isomorphic graphs was significantly reduced to 1595 pairs of graphs which are remain using the QR algorithm (this step is justified by

remark 3.16). This was the most intensive step computationally—it took an ordinary Linux home desktop around 25 minutes.

Then another program simply found the CDC's of each of the graphs which remained, and these were compared pairwise to check for isomorphism. This took around 5 seconds.



The images of the graphs were generated by importing the output of the C program into Mathematica. The vertices are coloured using an implementation of Brélaz's colouring algorithm. This produces a near-optimal vertex colouring for all the graphs. The "graph numbers" below correspond to the numbering given in McKay's list for non-isomorphic graphs on 8 vertices.

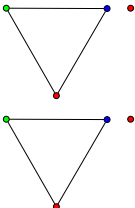
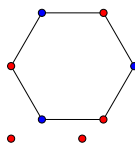
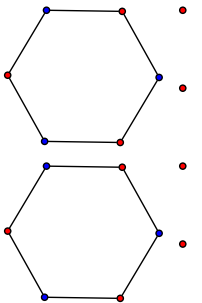

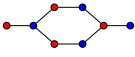
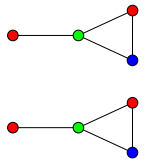
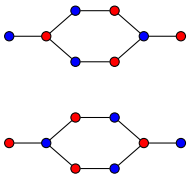
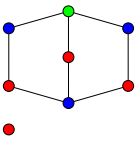
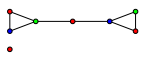
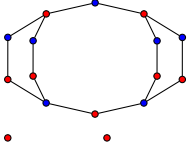
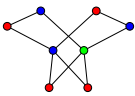
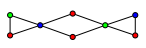
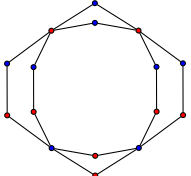
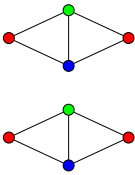
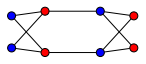
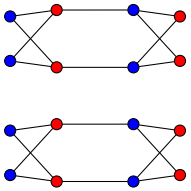
49

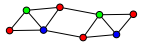
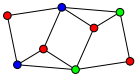
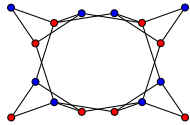
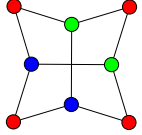
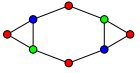
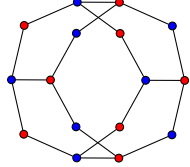
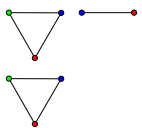
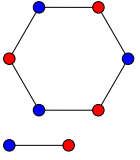
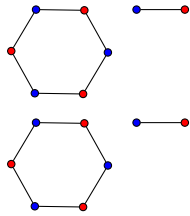
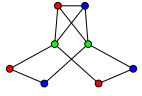
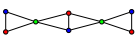
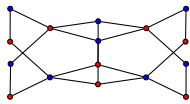
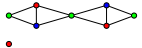
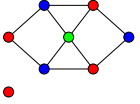
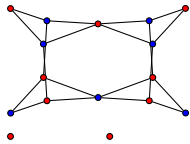
Graph Numbers	G	H	Eigenvalues (main eigenvalues denoted in bold)	CDC(G) \simeq CDC(H)
G: 958 H: 447			G: -1 -1 -1 -1 0 0 2 2 H: -2 -1 -1 0 0 1 1 2	

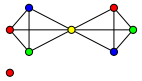
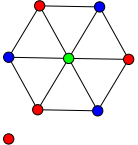
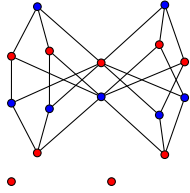
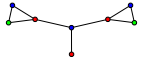
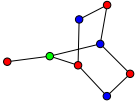
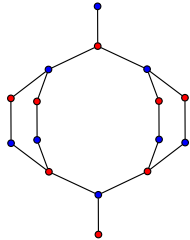
Graph Numbers	G	H	Eigenvalues (main eigenvalues denoted in bold)	$CDC(G) \simeq CDC(H)$
G: 1162 H: 1030			G: $-1 \ 1 \ -1.48 \ 0.31 \ 2.17 \ -2.17 \ -0.31 \ 1.48$ H: $-1 \ -1 \ -1.48 \ -1.48 \ 0.31 \ 0.31 \ 2.17 \ 2.17$	
G: 1164 H: 1032			G: $-2 \ -1 \ 0 \ 1 \ 1 \ -1.81 \ 0.47 \ 2.34$ H: $-1 \ -1 \ -1 \ 0 \ 2 \ -1.81 \ 0.47 \ 2.34$	
G: 1235 H: 1105			G: $-2 \ -1 \ 0 \ 1 \ 1 \ -2.32 \ 0.64 \ 2.68$ H: $-1 \ -1 \ -1 \ 0 \ 2 \ -2.32 \ 0.64 \ 2.68$	
G: 3494 H: 3392			G: $-1 \ -1 \ 0 \ 0 \ \frac{1}{2}(1-\sqrt{17}) \ \frac{1}{2}(1-\sqrt{17}) \ \frac{1}{2}(1+\sqrt{17}) \ \frac{1}{2}(1+\sqrt{17})$ H: $-1 \ 0 \ 0 \ 1 \ \frac{1}{2}(-1-\sqrt{17}) \ \frac{1}{2}(1-\sqrt{17}) \ \frac{1}{2}(\sqrt{17}-1) \ \frac{1}{2}(1+\sqrt{17})$	

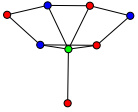
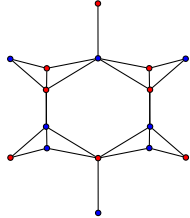

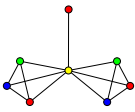
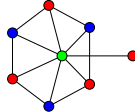
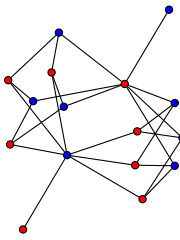
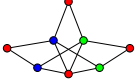
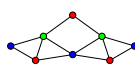
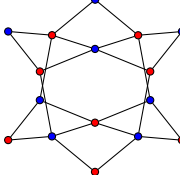
Graph Numbers	G	H	Eigenvalues (main eigenvalues denoted in bold)	CDC(G) \simeq CDC(H)
G: 3592 H: 3482			G: -1 -1 -2.27 0.14 3.13 -1.48 0.31 2.17 H: -1 1 -2.27 0.14 3.13 -2.17 -0.31 1.48	
G: 3779 H: 3413			G: -2 -2 0 1 1 1 $\frac{1}{2}(1-\sqrt{17})$ $\frac{1}{2}(1+\sqrt{17})$ H: -2 -1 -1 0 1 2 $\frac{1}{2}(1-\sqrt{17})$ $\frac{1}{2}(1+\sqrt{17})$	
G: 5629 H: 1270			G: -1 -1 -1 -1 -1 1 2 3 H: -2 -1 -1 -1 1 1 1 2	
G: 5718 H: 5684			G: -2 -2 -1 -1 1 1 1 3 H: -2 -1 -1 -1 -1 1 2 3	
G: 5753 H: 3887			G: -2 -1 -1 -1 0 0 2 3 H: -2 -2 -1 0 0 1 1 3	

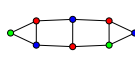
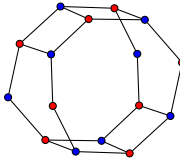
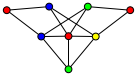
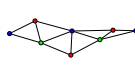
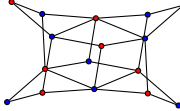
Graph Numbers	G	H	Eigenvalues (main eigenvalues denoted in bold)	$CDC(G) \simeq CDC(H)$
G: 5755 H: 3899			G: $-1 -1 -1 -1 \mathbf{0} \mathbf{2} \mathbf{1} -\sqrt{7} \mathbf{1} + \sqrt{7}$ H: $-2 -1 -1 \mathbf{0} \mathbf{1} \mathbf{1} \mathbf{1} -\sqrt{7} \mathbf{1} + \sqrt{7}$	
G: 5756 H: 3886			G: $-2 -1 -1 -1 \mathbf{1} \mathbf{2} \mathbf{1} -\sqrt{2} \mathbf{1} + \sqrt{2}$ H: $-2 -2 -1 \mathbf{1} \mathbf{1} \mathbf{1} \mathbf{1} -\sqrt{2} \mathbf{1} + \sqrt{2}$	
G: 5759 H: 3888			G: $-1 -1 -1 \mathbf{2} -\mathbf{2.20} -\mathbf{0.49} \mathbf{0.60} \mathbf{3.09}$ H: $-2 -1 \mathbf{1} \mathbf{1} -\mathbf{2.20} -\mathbf{0.49} \mathbf{0.60} \mathbf{3.09}$	

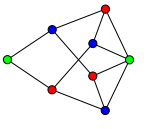
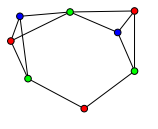
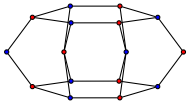
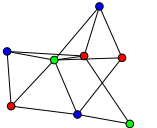
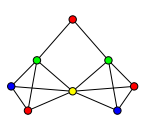
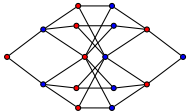
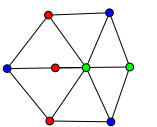
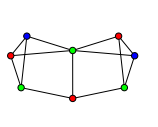
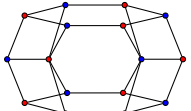
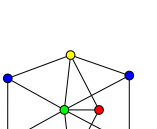
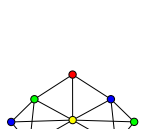
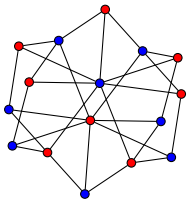
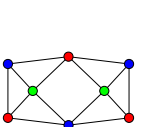
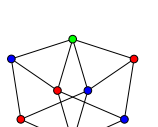
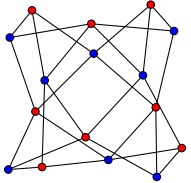
Graph Numbers	G	H	Eigenvalues (main eigenvalues denoted in bold)	$CDC(G) \simeq CDC(H)$
G: 5761 H: 3903			G: $-2 \ -1 \ -1 \ -1 \ -1 \ 2 \ 2 \ -\sqrt{3} \ 2+\sqrt{3}$ H: $-2 \ -2 \ -1 \ -1 \ 1 \ 1 \ 2 \ -\sqrt{3} \ 2+\sqrt{3}$	
G: 7012 H: 6471			G: $-2 \ 0 \ 1 \ 1 \ -2.29 \ -1.48 \ 0.55 \ 3.21$ H: $-1 \ -1 \ 0 \ 2 \ -2.29 \ -1.48 \ 0.55 \ 3.21$	
G: 7013 H: 6479			G: $-2 \ 1 \ 1 \ -1-\sqrt{2} \ \sqrt{2}-1 \ -1.34 \ 0.53 \ 2.81$ H: $-1 \ -1 \ 2 \ -1-\sqrt{2} \ \sqrt{2}-1 \ -1.34 \ 0.53 \ 2.81$	
G: 7015 H: 6481			G: $-2 \ -2 \ 1 \ 1 \ -1.79 \ -0.28 \ 0.56 \ 3.52$ H: $-2 \ -1 \ -1 \ 2 \ -1.79 \ -0.28 \ 0.56 \ 3.52$	

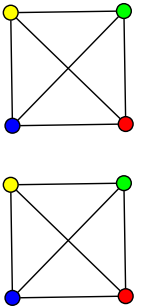
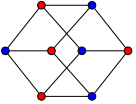
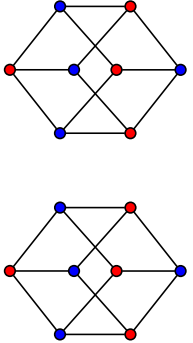
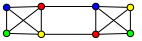
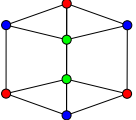
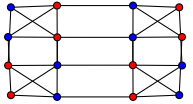
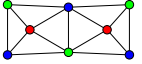
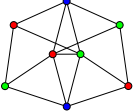
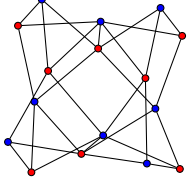
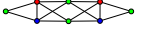
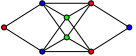
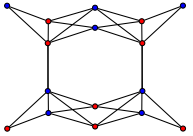
Graph Numbers	G	H	Eigenvalues (main eigenvalues denoted in bold)	$CDC(G) \simeq CDC(H)$
G: 7026 H: 6476			G: -2 -1 -1 1 1 -2.25 1.15 3.10 H: -1 -1 -1 -1 2 -2.25 1.15 3.10	
G: 7028 H: 6478			G: -2 -2 -1 1 1 -1.49 0.71 3.78 H: -2 -1 -1 -1 2 -1.49 0.71 3.78	
G: 7035 H: 6486			G: -2 -1 1 1 -2.68 -0.34 0.66 3.36 H: -1 -1 -1 2 -2.68 -0.34 0.66 3.36	
G: 7037 H: 6488			G: -2 -2 -1 1 1 -1.53 0.48 4.05 H: -2 -1 -1 -1 2 -1.53 0.48 4.05	
G: 10851 H: 10840			G: -2 -2 -1 -1 1 2 $\frac{1}{2}(3-\sqrt{17})$ $\frac{1}{2}(3+\sqrt{17})$ H: -2 -2 -2 1 1 1 $\frac{1}{2}(3-\sqrt{17})$ $\frac{1}{2}(3+\sqrt{17})$	

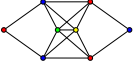
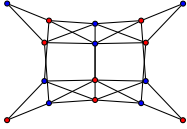
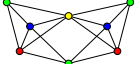
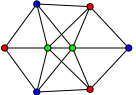
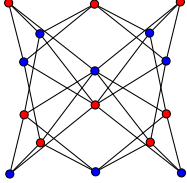
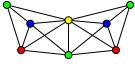
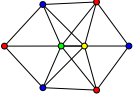
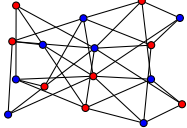
Graph Numbers	G	H	Eigenvalues (main eigenvalues denoted in bold)	$CDC(G) \simeq CDC(H)$
G: 11716 H: 5358			G: -1 -1 -1 -1 -1 -1 3 3 H: -3 -1 -1 -1 1 1 1 3	
G: 11731 H: 10867			G: -2 -1 -1 0 $\frac{1}{2}(1-\sqrt{17})$ $\frac{1}{2}(3-\sqrt{17})$ $\frac{1}{2}(1+\sqrt{17})$ $\frac{1}{2}(3+\sqrt{17})$ H: -2 -1 0 1 $\frac{1}{2}(-1-\sqrt{17})$ $\frac{1}{2}(3-\sqrt{17})$ $\frac{1}{2}(\sqrt{17}-1)$ $\frac{1}{2}(3+\sqrt{17})$	
G: 11742 H: 10841			G: -1 -1 2 -1 $-\sqrt{2}$ $\sqrt{2}-1$ -1.60 -0.32 3.92 H: -2 1 1 -1 $-\sqrt{2}$ $\sqrt{2}-1$ -1.60 -0.32 3.92	
G: 11747 H: 10838			G: -1 -1 -1 0 0 2 $\frac{1}{2}(1-\sqrt{41})$ $\frac{1}{2}(1+\sqrt{41})$ H: -2 -1 0 0 1 1 $\frac{1}{2}(1-\sqrt{41})$ $\frac{1}{2}(1+\sqrt{41})$	

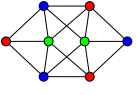
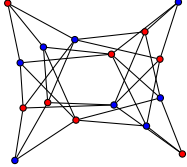
Graph Numbers	G	H	Eigenvalues (main eigenvalues denoted in bold)	$CDC(G) \simeq CDC(H)$
G: 11748 H: 10839			G: -1 -1 -1 -1 2 -2.30 0.21 4.08 H: -2 -1 -1 1 1 -2.30 0.21 4.08	
G: 11751 H: 10849			G: -1 -1 -1 2 -2.39 -1.35 0.60 4.14 H: -2 -1 1 1 -2.39 -1.35 0.60 4.14	
G: 11752 H: 10850			G: -2 -1 -1 -1 2 -1.64 0.14 4.50 H: -2 -2 -1 1 1 -1.64 0.14 4.50	
G: 11755 H: 10887			G: -1 -1 -2.38 -0.72 4.10 -1.48 0.31 2.17 H: -1 1 -2.38 -0.72 4.10 -2.17 -0.31 1.48	

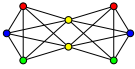
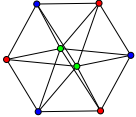
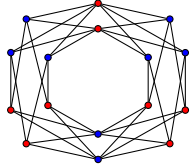
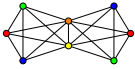
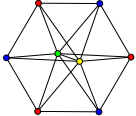
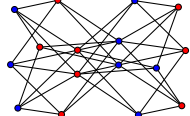
Graph Numbers	G	H	Eigenvalues (main eigenvalues denoted in bold)	$CDC(G) \simeq CDC(H)$
G: 11761 H: 10897			G: $-1 -1 -1 -1 0 2 \mathbf{1} -\sqrt{13} \mathbf{1} + \sqrt{13}$ H: $-2 -1 -1 0 1 1 \mathbf{1} -\sqrt{13} \mathbf{1} + \sqrt{13}$	
G: 11762 H: 10898			G: $-2 -1 -1 -1 -1 -1 \mathbf{2} \mathbf{5}$ H: $-2 -2 -1 -1 -1 1 \mathbf{1} \mathbf{5}$	

Bibliography

- [1] S. Axler. *Linear Algebra Done Right*. Springer Verlag, 3rd edition, 2015.
- [2] N. Biggs. *Spectra of Graphs*. Springer Verlag, 2nd edition, 2016.
- [3] A. E. Brouwer and W. H. Haemers. *Spectra of Graphs*. Springer Verlag, 1st edition, 2012.
- [4] L. Collins and I. Sciriha. On the walks and canonical double coverings of graphs with the same main eigenspace. *arXiv:1906.05790 [math.CO]*, 2019.
- [5] D. Cvetković and M. Petrić. A table of connected graphs on six vertices. *Discrete Mathematics*, 50:37–49, 1984.
- [6] D. M. Cvetković, M. Doob, and H. Sachs. *Spectra of Graphs: Theory and Applications*. Heidelberg : Johann Ambrosius Barth, 3rd edition, 1995.
- [7] R. Diestel. *Graph Theory*. Springer Verlag, 5th edition, 2016.
- [8] C. Godsil and G. Royle. *Algebraic Graph Theory*, chapter 8, pages 163–192. Springer Verlag, 1st edition, 2001.
- [9] I. N. Herstein. *Topics in Algebra*, chapter 3, pages 153–161. John Wiley & Sons, 2nd edition, 1975.
- [10] S. Kneebone. Königsberg bridge puzzle illustration. URL: <https://simonkneebone.com/2011/11/29/konigsberg-bridge-puzzle/>, [Online]. Last accessed 28-04-2019].

- [11] J. Lauri, R. Mizzi, and R. Scapellato. Two-fold orbital digraphs and other constructions. *International Journal of Pure and Applied Mathematics*, 1:63–93, 2004.
- [12] M. Marcus and R. Ree. Diagonals of doubly stochastic matrices. *The Quarterly Journal of Mathematics*, 10:296–302, 1959.
- [13] B. McKay. Graph data. URL: <https://cs.anu.edu.au/people/Brendan.McKay/data/graphs.html>, [Online]. Last accessed 28-04-2019].
- [14] P. Rowlinson. The main eigenvalues of a graph: a survey. *Applicable Analysis and Discrete Mathematics*, 1:445–471, 2007.
- [15] B. Russell and A. N. Whitehead. *Principia Mathematica (vol. 2)*, chapter 8, page 384. Cambridge University Press, 1912.
- [16] I. Sciriha and D. M. Cardoso. Necessary and sufficient conditions for a Hamiltonian graph. *Journal of Combinatorial Mathematics and Combinatorial Computing*, 80:127–150, 2012.

Index

- $f \upharpoonright X$, *see* domain restriction
- k -cycle, *see* cycle
- n -cycle, *see* cycle
- adjacency matrix, 4
- bipartite, 3
- bipartite double covering, *see* canonical double covering
- Birkhoff–von Neumann, 9
- canonical double covering, 34
- cardinality, 1
- Cartesian product, *see* sets
- CDC, *see* canonical double covering
- comain, 24
- complement, 4
- complete graph, 4
- component, 3
- connected graph, 3
- convex, 10
 - combination, 10
- cospectral, 4
- cycle, 3, 4
- degree, 2
- disconnected graph, 3
- domain restriction, 2
- even cycle, *see* cycle
- functions, 1
- Gauss' lemma, 23
- graph
 - complement, *see* complement
 - definition, 2
 - simple graph, 2
 - union, *see* union
- Handshaking lemma, 5
- Hermitian operator, 12
- hiearchy, 40
- induced subgraph, *see* subgraph
- inner product, 12
- inner product space, *see* inner product
- isolated vertex, 4
- isomorphic, *see* isomorphism
- isomorphism, 2
- main

- angles, 24
- eigenspace, 29
- eigenvalue, 24
- polynomial, 26
- matrices, 1
- natural numbers, 1
- neighbour, 2
- number of walks, 20
 - generating function, 26, 28
- odd cycle, *see* cycle
- orthogonal projection, 13
- partite set, *see* bipartite
- permutation, *see* permutation matrix
- permutation matrix, 8
- Perron–Frobenius, 25
- polynomial, 22
 - content, 22
 - primitive, 22
- power set, 1
- projection, *see* orthogonal projection
- restriction, *see* domain restriction
- sets, 1
 - Cartesian product, 1
 - k -subsets, 1
- spectral theorem, 16
- subgraph, 3
- TF-isomorphism, 40
- union, 4
- vertex
 - degree, 2
 - neighbour, *see* neighbour
- walk, 3
 - k -walk, 3
- walk matrix, 30
 - k -walk matrix, 31